

Heating cable solutions for temperature-related problems



EasyHeat™ Residential and Commercial Solutions

Depend on EasyHeat™ products for proper pipe temperatures, free-flowing roof gutters, safer walkways and warm floors.





For over 50 years, our expertise has provided the broadest line of heating cables in the industry, ensuring operational efficiency, safety and comfort.

With our extensive range of EasyHeat™ electrical heating cable products, Emerson provides economical and preventative solutions to temperature related problems in any application. From eliminating frozen pipes, and ice dams on roofs, to keeping steps, walks and driveways clear and free of snow... From maintaining process pipe temperatures in a plant, to maintaining comfortable temperatures on your tile floor, we have the solution.

EasyHeat™ Table of Contents

TABLE OF CONTENTS

Description	Page	Residential	Commercial
Pipe Tracing			
Pipe Freeze Protection Product Selection Guide	5		
Pipe Temperature Maintenance Selection Guide	6		
AHB Cable	7	X	X
Freeze Free™ Cable	9	X	
Freeze Free™ Accessories	14	X	
HB Cable	15		X
HB2 Cable	16		X
PSR Cable	17	X	X
SR Trace™ Cable	20	X	X
SR Trace™ Connection Kits and Accessories	25	X	X
TSR Cable	27		X
TSR Connection Kits and Accessories	33		X
Domestic Hot Water Temperature Maintenance System	35		X
HSR Cable	38		X
MI Trace Cable	43		X
Pipe Tracing Controls	44		X
Pipe Tracing Accessories	47	X	X
EGPC Digital Electronic Controller	48		X
AXPC100EGPC Combination Power Connection and Digital Electronic Controller	49		X
Crankcase Heaters	50		X
Roof and Gutter De-Icing			
Roof and Gutter De-Icing Product Selection Guide	52		
ADKS Cable	53	X	
PSR Cable	58	X	X
SR Trace Cable	60	X	X
SR Trace Accessories	63	X	X
RG Roof and Gutter Cable	65	X	X
RG Roof and Gutter Cable Accessories	68	X	X
Roof and Gutter De-Icing Controls	70	X	X
Snow Melting			
Snow Melting Product Selection Guide	74		
Sno* Melter™ Mats	75	X	X
SMK Cable Kits	82	X	X
MI Trace Cable	83		X
Snow Melting Controls	84	X	X
Snow Melting Accessories	88	X	X



AHB



Freeze Free



Freeze Free Accessories



HB/ HB2



PSR



SR Trace



SR Trace Tracing Accessories



TSR



TSR Accessories



Hot Water Temperature Maintenance System



HSR



MI Trace



Pipe Tracing Controls



Pipe Tracing Accessories



EGPC/AXPC100EGPC



Crankcase Heaters



ADKS



RG



Roof/Gutter De-Icing Accessories



Roof/Gutter De-Icing Controls



Sno* Melter Mats



SMK Cable Kits



Snow Melting Controls

Note: Residential and commercial product categories are typical usage applications. Verify with your local EasyHeat sales representative for more information.

EasyHeat™ Table of Contents

Description	Page	Residential	Commercial
In-Line Heating			
In-Line Heating Selection Guide	90		
In-Line Heater	91	X	
In-Line Self-Regulating Heating System	92	X	
SL Thermostatic Controllers	93	X	
Thermal Storage			
Thermal Storage Product Selection Guide	95		
XD Cable	96	X	X
Thermal Storage Controls	98	X	X
Warm Tiles™ Floor Warming			
Warm Tiles Floor Warming Product Selection Guide	100		
DFT Cable	101	X	
DMC Cable	105	X	
SAM Mat	109	X	
Elite WTE Mat	113	X	
Thermostats	118	X	
Accessories	120	X	



ILH



ILSR



SL Thermostatic Controllers



XD Cable Kits



Thermal Storage Controls



DFT



DMC



SAM



WTE



Thermostats



Accessories

TABLE OF CONTENTS

Note: Residential and commercial product categories are typical usage applications. Verify with your local EasyHeat sales representative for more information.



Pipe Tracing

To maintain proper pipe temperatures in applications that range from residential/commercial freeze protection to industrial viscosity maintenance and flow-control processes, rely on the proven performance of EasyHeat™ pipe tracing products. With a complete range of constant wattage and self-regulating heating cables that provide 3 to 20 Watts per foot of heat @ +50 °F (+10 °C) ambient temperature, Emerson provides dependable pipe tracing solutions for any application.

EasyHeat™ Pipe Freeze Protection Selection Guide

Criteria	AHB	Freeze Free	PSR	SR Trace	TSR	HSR	HB/HB2
1. What is the pipe application?							
Typical Application	Residential	Residential	Residential Commercial	Residential Commercial	Commercial	Commercial	Commercial
Water Supply Line	✓	✓	✓	✓	✓	✓	✓ ②
Drain Line	—	✓	✓	✓	✓	✓	✓
Oil line/Fuel Line	—	—	✓	✓	✓	✓	—
2. What is the manner of the install?							
Installation Manner	Outside Pipe	Outside Pipe	Outside Pipe	Outside Pipe	Outside Pipe	Outside Pipe	Outside Pipe
3. What is the size/diameter of the pipe?							
Pipe Diameter	3/8 in - 1-1/2 in	1/2 in - 2 in	1/2 in - 8 in	1/2 in - 8 in ①	1/2 in or more ①	1/2 in or more ①	3/8 in - 6 in
4. What is the material of the pipe?							
Plastic (PEX, PVC, Polybutelene, etc.)	✓	✓	✓	✓	✓	✓	—
Metal (Copper, Steel, etc.)	✓	✓	✓	✓	✓	✓	✓
5. Where is the location of the pipe?							
Above Ground	✓	✓	✓	✓	✓	✓	✓
Below Ground	—	—	— ①	— ①	— ①	— ①	—
Wet Location	—	—	✓	✓	✓	✓	—
Dry Location	✓	✓	✓	✓	✓	✓	—
6. What is the power rating?							
Power Rating	Constant: 7 Watts/ft	Self-regulating: 3 Watts/ft @ +50 °F (+10 °C)	Self-regulating: 5 Watts/ft @ +50 °F (+10 °C)	Self-regulating: 3 Watts/ft @ +50 °F (+10 °C) 5 Watts/ft @ +50 °F (+10 °C) 8 Watts/ft @ +50 °F (+10 °C)	Self-regulating: 3 Watts/ft @ +50 °F (+10 °C) 5 Watts/ft @ +50 °F (+10 °C) 8 Watts/ft @ +50 °F (+10 °C) 10 Watts/ft @ +50 °F (+10 °C)	Self-regulating: 5 Watts/ft @ +50 °F (+10 °C) 10 Watts/ft @ +50 °F (+10 °C) 15 Watts/ft @ +50 °F (+10 °C) 20 Watts/ft @ +50 °F (+10 °C)	Constant: 7 Watts/ft
7. What is the available supply voltage?							
Supply Voltage (Vac)	120	120	120, 240	120, 208, 240, 277	120, 208, 240, 277	120, 208, 240, 277	120, 240
Power Cord/Termination	2 ft (0.6 m)	2.5 ft (0.8 m) ③	2.5 ft (0.8 m)	①③	①③	①③	2 ft (0.6 m)
8. How much length of heating cable is needed?							
Cable Lengths	3 ft - 80 ft (0.91 m - 24.4 m)	Cut-to-length [75 ft (22.9 m) Max]	6 ft - 100 ft (1.8 m - 30.5 m)	Cut-to-length ④	Cut-to-length ①	Cut-to-length ①	3.28 ft to 78.74 ft (1 m - 24 m)

✓ Applicable

— Not Applicable

① Verify with your local EasyHeat sales representative.

② Primarily for HVAC/Refrigeration applications.

③ Additional accessories are required for cable termination. See catalog page of the specific cable accessories.

④ See catalog page of the specific cable.

EasyHeat™ Pipe Temperature Maintenance Product Selection Guide

Criteria	PSR	SR Trace	TSR ②	HSR	MI Trace
1. What is the maintenance temperature?					
Maximum Maintenance Temperature	+150 °F (+66 °C)	+150 °F (+66 °C)	+150 °F (+66 °C)	+250 °F (+121 °C)	+800 °F (+427 °C)
2. What is the required maximum intermittent exposure temperature?					
Maximum Intermittent Exposure Temperature	+185 °F (+85 °C)	+185 °F (+85 °C)	+185 °F (+85 °C)	+420 °F (+216 °C)	+1100 °F (+593 °C)
3. Where is the location of the installation?					
Indoor	✓	✓	✓	✓	✓
Outdoor	✓	✓	✓	✓	✓
4. What is the classification of the area where the installation will be?					
Area Classification	Ordinary	Ordinary	Ordinary Class I, Division 2	Ordinary Class I, Division 2	Ordinary Class I, Division 1
T-rating for Hazardous (Classified) Locations	—	—	T5	T3	T1 to T6 (application dependent)
5. What is the size/diameter of the pipe?					
Pipe Diameter	1/2 in - 8 in	1/2 in - 8 in	1/2 in or more	1/2 in or more	①
6. What is the pipe material?					
Plastic (PEX, PVC, Polybutelene, etc.)	✓	✓	✓	✓	—
Metal (Copper, Steel, etc.)	✓	✓	✓	✓	✓
7. What is the required outer jacket?					
Polyolefin	✓	✓	✓	—	—
Fluoropolymer	—	—	✓	✓	—
Alloy 825	—	—	—	—	✓
8. What is the power rating?					
Power Rating	Self-regulating: 5 Watts/ft @ +50 °F (+10 °C)	Self-regulating: 3 Watts/ft @ +50 °F (+10 °C) 5 Watts/ft @ +50 °F (+10 °C) 8 Watts/ft @ +50 °F (+10 °C)	Self-regulating: 3 Watts/ft @ +50 °F (+10 °C) 5 Watts/ft @ +50 °F (+10 °C) 8 Watts/ft @ +50 °F (+10 °C) 10 Watts/ft @ +50 °F (+10 °C)	Self-regulating: 5 Watts/ft @ +50 °F (+10 °C) 10 Watts/ft @ +50 °F (+10 °C) 15 Watts/ft @ +50 °F (+10 °C) 20 Watts/ft @ +50 °F (+10 °C)	Constant: Up to 88 Watts/ft (Max)
9. What is the available supply voltage?					
Supply Voltage (Vac)	120, 208, 240, 277	120, 208, 240, 277	120, 208, 240, 277	120, 208, 240, 277	120, 208, 240, 277, 347, 480, 600
10. How much length of heating cable is needed?					
Cable Lengths	6 ft - 100 ft (1.8 m - 30.5 m)	Cut-to-length ①	Cut-to-length ①	Cut-to-length ①	Made-to-order ①

✓ Applicable

— Not Applicable

① Verify with your local EasyHeat sales representative.

② All TSR cables are also available with fluoropolymer over jacket (for enhanced chemical resistance, change suffix -J to -F).

EasyHeat™ AHB Cable

Pipe Freeze Protection, Constant Wattage, Pre-Terminated. For Residential Applications.

Product Overview

- The AHB automatic electric water pipe heating cable is a pre-assembled and ready-to-install cable that prevents metal and plastic supply pipes from freezing.
- AHB units are activated and de-activated by an integrated energy saving thermostat.

Applications

- Suitable for commercial and residential plastic or metal water supply pipes subject to freezing temperatures.

Features

- Keeps water flowing at ambient temperatures down to -40 °F (-40 °C).
- Cables are rated at 7 Watts per foot (0.30 m).
- Built-in thermostat turns on at +38 °F (+3 °C) or below and turns off at +45 °F (+7 °C) and above.
- Plugs into a standard 120 Vac outlet, must be GFCI protected.
- Each cable consists of tough XLPE inner insulation, a continuous ground braid and weather resistant PVC (high-low temperature) outer jacket.
- Protects metal and plastic water-filled pipes up to 1-1/2 in (38.1 mm) in diameter.
- Pre-assembled and ready to install.
- Available in 3 ft (0.9 m) increments up to 18 ft (5.5 m) and longer increments up to 80 ft (24.4 m).
- Integral thermostat saves energy by powering the cable only when needed.
- One year limited warranty.

Accessories

- It is recommended to use EasyHeat HCA application tape or good quality electrical tape with a minimum +176 °F (+80 °C) temperature rating to secure heating cable(s) to pipes. See *EasyHeat Pipe Tracing Accessories*.



Certifications

- UL Listed to Canadian Safety Standards and CSA Certified when used in accordance with instructions on water filled plastic or metal pipes.

Notes

- Per NEC and CEC requirements ALWAYS use a ground fault protection device (GFCI) to reduce the danger of fire from a damaged or improperly installed heating cable. Electrical fault currents caused by damaged or improperly installed cable MAY NOT BE LARGE ENOUGH to trip a conventional circuit breaker.
- Heating cables must be installed in compliance with all national, state/provincial and local codes. Check with your local electrical inspector for specific details.
- Do not spiral or wrap the cable around a pipe.
- Never cut or splice the cable.
- Do not allow the cable to touch or cross itself or another heating cable at any point.
- Do not use a cable on a pipe shorter than specified on the cable package and cord tag.
- For two cable installation, please refer to product Installation Instructions.
- The minimum installation temperature of the cable is +15 °F (-10 °C).
- Maximum 1/2 in (13 mm) fiberglass or equivalent non-flammable foam pipe insulation. Never use insulation that is too thick or that is flammable.
- Vapor seal must be used when using fiberglass insulation (not needed for waterproof insulation).
- The complete installation (including the insulation) must be at least 1/2" away from any combustible material.
- Never use on flexible vinyl tubing (garden hose), on buried pipes, on pipes carrying any fluid other than water, or any non-pipe heating applications such as roof and gutter de-icing or driveway snow melting.
- Do not use extension cord.

Illustrated Features

Indicator Light

Indicator light in the AHB plug assures the system has power.

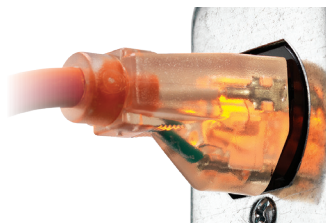

Built-In Thermostat

Energy efficient built-in thermostat provides the right amount of energy only when needed.



EasyHeat™ AHB Cable

Pipe Freeze Protection, Constant Wattage, Pre-Terminated. For Residential Applications.

How To Determine The Length of Cable You Need

Pipes must be at least 3 ft (0.9 m) long and at least 3/8 in (9.5 mm) and no more than 1-1/2 in (38.1 mm) in diameter. For pipes of other sizes, please refer to the product selection guide for other cable options.

- Measure your pipe straight along the bottom of a horizontal pipe or on the “weather side” of a vertical pipe (including valves).
- Single cables are available to protect the lengths of pipe listed in the single cable pipe length selection chart key.
- If a cable suitable for your pipe is unavailable or out of stock, you can use two cables together on one pipe. For additional information, please refer to product installation instructions.

Single Cable Pipe Length Selection Chart Key

Pipe Length ft (m)	Catalog Number
3 – 4 (0.9 – 1.2)	AHB013A
3 – 7 (0.9 – 2.1)	AHB016A
6 – 10 (1.8 – 3.0)	AHB019A
9 – 13 (2.7 – 4.0)	AHB112A
12 – 16 (3.7 – 4.9)	AHB115A
15 – 19 (4.6 – 5.8)	AHB118
21 – 25 (6.4 – 7.6)	AHB124
27 – 31 (8.2 – 9.4)	AHB130
37 – 41 (11.3 – 12.5)	AHB140
57 – 61 (17.4 – 18.6)	AHB160
77 – 81 (23.5 – 24.7)	AHB180

Product Selection

Catalog Number	Description	Carton Quantity	Carton Weight lb (kg)	UPC
AHB013A ①	3 ft (0.91 m), 21 Watts	5	6 (2.7)	01362718874
AHB016A ①	6 ft (1.83 m), 42 Watts	5	7 (3.2)	01362718875
AHB019A ①	9 ft (2.74 m), 63 Watts	5	9 (4.1)	01362718876
AHB112A ①	12 ft (3.66 m), 84 Watts	5	10 (4.5)	01362718877
AHB115A ①	15 ft (4.58 m), 105 Watts	5	11 (5.0)	01362718879
AHB118 ①	18 ft (5.49 m), 126 Watts	5	7 (3.2)	01362710955
AHB124	24 ft (7.31m), 168 Watts	5	8 (3.6)	01362710956
AHB130	30 ft (9.14 m), 211 Watts	5	9 (4.1)	01362710957
AHB140	40 ft (12.19 m), 280 Watts	5	12 (5.4)	01362710958
AHB160	60 ft (18.29 m), 420 Watts	5	15 (6.8)	01362710959
AHB180	80 ft (24.38 m), 560 Watts	5	20 (9.1)	01362710960
GTXAHB	Starter kit: 2 each of ①'s above	1	19 (8.6)	01362710948
GWJAHB	Jumbo kit: 5 each of ①'s above	1	55 (25.0)	01362710949

① Individual cables are available as part of a kit, see GTXAHB or GWJAHB.

Notes

- Cable must be long enough to run along bottom of horizontal pipes or weather side of vertical pipes (including valves) without crossing or spiraling.

EasyHeat™ Freeze Free™ Cable

Pipe Freeze Protection, Self-Regulating, Cut-to-Length. For Residential Applications.

Product Overview

- Freeze Free self-regulating pipe heating cables provide flexible protection against pipe freeze-ups.
- Cut-to-length capability on the job is ideal for installations that require protection of numerous pipes of varied lengths.
- The self-regulating effect of the cable reduces power consumption when the pipe does not require freeze protection.
- Increases Watts per foot the colder it gets and decreases when the temperature gets warmer.

Applications

- Residential plastic or metal water supply and drain pipes subject to freezing temperatures.
- Water supply lines underneath mobile and manufactured homes.
- Pipes in cottages, barns and outbuildings that are not regularly heated.

Features

- 120 Vac operating voltage.
- Keeps plastic and metal water pipes from freezing down to -60 °F (-51 °C).
- Braided metal jacket provides an electrical ground as well as protection against damage in dry locations.
- Cables are rated at 3 Watts per foot (0.30 m), +50 °F (+10 °C); 75 ft (22.86 m) maximum circuit length.
- Available on reels of 100 ft, 300 ft, and 500 ft (30.48 m, 91.44 m, and 152.40 m) and can be cut to desired lengths per application.
- Pre-packaged lengths of 5 ft and 15 ft (1.52 m and 4.57 m) are also available.
- Can be wrapped over itself (overlapped), if necessary, when installed on pipes, valves or flanges.
- One year limited warranty.

Related Products

- Fused plug kits connect one Freeze Free cable into an electrical outlet and a cable end seal to ensure safe and proper usage:
 - 10802
 - 10803
- It is recommended that heating cables for freeze protection be controlled by a thermostat to minimize energy consumption. Control options available:
 - EH38 Pre-Set Thermostat

Accessories

- Installation tape and caution labels are available. See *EasyHeat Freeze Free Accessories*.



Freeze Free™ Cable



10802 Connection Kit



Certifications

- UL Listed to US Safety Standards and CSA Certified.

Notes

- *Per NEC and CEC requirements ALWAYS use a ground fault protection device (GFEP) to reduce the danger of fire from a damaged or improperly installed heating cable. Electrical fault currents caused by damaged or improperly installed cable MAY NOT BE LARGE ENOUGH to trip a conventional circuit breaker.*
- *Heating cables must be installed in compliance with all national, state/provincial and local codes. Check with your local electrical inspector for specific details.*
- *The Freeze Free orange cable connector housing and fiberglass thermal insulation with vapor seal must be kept dry and away from water to avoid possible electrical shock or fire.*
- *Only use on plastic and metal domestic water pipes (such as PVC, PEX or polybutylene).*
- *Never use on flexible vinyl tubing (garden hose), on buried pipes, on pipes carrying any fluid other than water, or any non-pipe heating applications such as roof and gutter de-icing or driveway snow melting.*
- *Use 1/2 in (12.77 mm) fiberglass pipe insulation with vapor seal.*
- *Never expose the cable to temperatures above +150 °F (+66 °C), this will shorten the life of the cable.*
- *Only use the fused plug kits 10802 and 10803 for making connections.*
- *To avoid short circuits, never twist the wires inside the Freeze Free cable together or allow them to touch each other or the outer braid.*
- *Only cut the Freeze Free cable jacket at the ends when attaching the fused plug and end seal.*
- *Never use nails, metal clamps, wires or other devices that might cut the cable to support the cable along the pipe.*
- *Only use 1/2 in (12.7 mm) or 1 in (25.4 mm) vinyl or fiberglass tape to attach cable to pipe.*
- *Do not use extension cord.*
- *Use 1/2 in (12.77 mm) fiberglass with vapor seal insulation or equivalent non-combustible and nonflammable.*
- *Maximum 75 ft (22.86 m) length of freeze free connected per fused plug.*
- *Do not twist or expose the wire under the yellow jacket when connecting to the plug to avoid short circuits.*

EasyHeat™ Freeze Free™ Cable

Pipe Freeze Protection, Self-Regulating, Cut-to-Length. For Residential Applications.

Illustrated Features

A special self-regulating core is at the center of the Freeze Free cable. This core is conductive and adjusts according to the surrounding temperatures. When it is cold, the cable's core has many conductive paths that generate enough heat to keep the water flowing in the pipe. As the surrounding temperature warms, there are fewer conductive paths and less heat is generated.

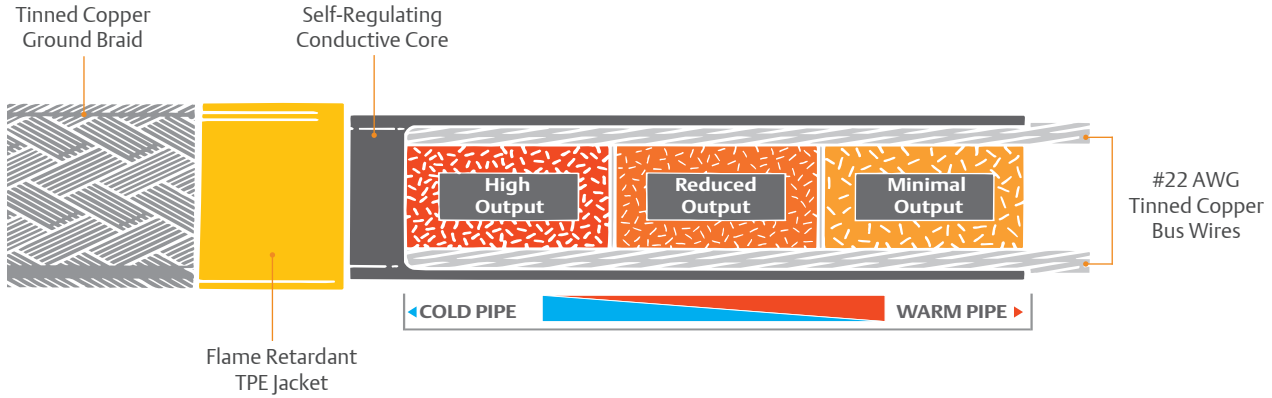

PIPE TRACING

Performance Information

Nominal Power Output on Metal Pipe

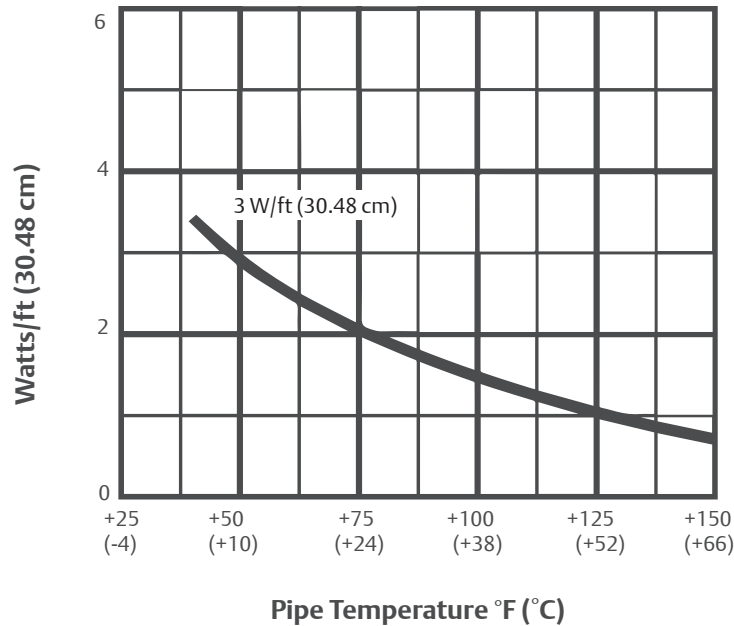

EasyHeat™ Freeze Free™ Cable

Pipe Freeze Protection, Self-Regulating, Cut-to-Length. For Residential Applications.

Cable Application

Freeze Free cable can be applied on water filled plastic or metal pipes up to 2 in (50.80 mm) in diameter. On smaller size pipes, the cable can usually be applied straight along the pipe. However, on longer pipes and especially at lower temperatures, the cable must be spiraled around the pipe. This ensures adequate heat is applied to the pipes to keep them from freezing. The table below indicates the application requirements for plastic and metal pipes.

Lowest Expected Temperature Table

	Plastic Pipe Diameter in (cm)						Metal Pipe in (cm)					
	1/2 (1.27)	3/4 (1.90)	1 (2.54)	1-1/4 (3.17)	1-1/2 (3.81)	2 (5.08)	1/2 (1.27)	3/4 (1.90)	1 (2.54)	1-1/4 (3.17)	1-1/2 (3.81)	2 (5.08)
Heating Cable Required Per Foot of Pipe ft (cm)												
+20 °F (-7 °C)	1 (30.48)	1 (30.48)	1 (30.48)	1 (30.48)	1 (30.48)	1 (30.48)	1 (30.48)	1 (30.48)	1 (30.48)	1 (30.48)	1 (30.48)	1 (30.48)
0 °F (-18 °C)	1 (30.48)	1.1 (33.53)	1.3 (39.62)	1.6 (48.76)	1.8 (54.86)	2.1 (64.01)	1 (30.48)	1 (30.48)	1 (30.48)	1.1 (33.53)	1.2 (36.57)	1.5 (45.72)
-20 °F (-29 °C)	1.5 (45.72)	1.7 (51.82)	2 (60.96)	2.3 (70.10)	2.5 (76.20)	3 (91.44)	1 (30.48)	1.1 (33.53)	1.3 (39.62)	1.6 (48.76)	1.8 (54.86)	2.2 (67.05)
-40 °F (-40 °C)	2 (60.96)	2.3 (70.10)	2.7 (82.29)	3.2 (97.53)	3.6 (109.72)	4.3 (131.06)	1.3 (39.62)	1.5 (45.72)	1.8 (54.86)	2.1 (64.01)	2.4 (73.15)	2.8 (85.34)
-60 °F (-51 °C)	2.4 (73.15)	2.9 (88.39)	3.3 (100.58)	4.1 (124.96)	4.7 (143.25)	5.4 (164.59)	1.7 (51.82)	2 (60.96)	2.4 (73.15)	2.9 (88.39)	3.2 (97.53)	3.9 (118.87)

PIPE TRACING

Note:

- Shaded selections can run straight on pipe.
- Unshaded selections must be spiraled evenly along the pipe.

EasyHeat™ Freeze Free™ Cable

Pipe Freeze Protection, Self-Regulating, Cut-to-Length. For Residential Applications.

How To Determine the Length of Cable You Need (Maximum Circuit Length: 75 Feet)

Step 1: Collect the Following Necessary Information

Example:

- Pipe Size
 - outside diameter
 - length
- Lowest expected air temperature: (disregard windchill, it has been figured into the length selection chart)
- Number of valves and spigots
- Distance from pipe to electrical outlet

Step 2: Refer To The Length Selection Charts

These charts will tell you the length of the cable you need per foot of pipe and also the recommended distance to leave between each spiral wrap of cable on the pipe.

How To Use the Length Selection Chart

Choose either Chart #1 or Chart #2 for your type of pipe (plastic or metal). Read down to find your pipe diameter, then read across to the box below your lowest expected temperature. The first number appearing in the box will tell you the length (feet) of cable you need per foot of pipe. The second number indicates the recommended distance between each spiral wrap of cable on the pipe. The abbreviation “str” indicates that the cable should be run in a straight line instead of spiral wrap.

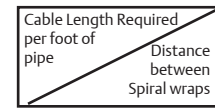

*“str” denotes straight cable (not spiraled)

Example

- Your pipe diameter is 1-1/2 in
- Your lowest expected temperature is -20 °F (-29 °C)
- Your pipe length is 12 ft

From Chart #1:

- You need 2.5 ft of cable per foot of pipe for plastic pipes

From Chart #2:

- You need 1.8 ft of cable per foot of pipe for metal pipes

Chart #1: Length Selection for Plastic Pipes

(based on the use of 1/2 in insulation)

Lowest Expected Temperature

Pipe Dia.	+20°F (-7°C)	0°F (-18°C)	-20°F (-29°C)	+40°F (-40°C)	-60°F (-51°C)
1/2"	1' str.	1' str.	1.5' 2-3/8"	2' 1-1/2"	2.4' 1-1/4"
3/4"	1' str.	1.1' 7-1/4"	1.7' 2-3/8"	2.3' 1-1/2"	2.9' 1-1/4"
1"	1' str.	1.3' 5"	2' 2-3/8"	2.7' 1-5/8"	3.3' 1-3/8"
1-1/4"	1' str.	1.6' 4-1/4"	2.3' 2-1/2"	3.2' 1-3/4"	4.1' 1-3/8"
1-1/2"	1' str.	1.8' 4"	2.5' 2-5/8"	3.6' 1-3/4"	4.7' 1-3/8"
2"	1' str.	2.1' 4"	3' 2-5/8"	4.3' 1-3/4"	5.4' 1-1/8"

Chart #2: Length Selection for Metal Pipes

(based on the use of 1/2 in insulation)

Lowest Expected Temperature

Pipe Dia.	+20°F (-7°C)	0°F (-18°C)	-20°F (-29°C)	+40°F (-40°C)	-60°F (-51°C)
1/2"	1' str.	1' str.	1' str.	1.3' 3-1/8"	1.7' 2"
3/4"	1' str.	1' str.	1.1' 7-1/4"	1.5' 3"	2' 2"
1"	1' str.	1' str.	1.3' 5"	1.8' 2-3/4"	2.4' 1-7/8"
1-1/4"	1' str.	1.1' 11-1/2"	1.6' 4-1/4"	2.1' 2-7/8"	2.9' 1-7/8"
1-1/2"	1' str.	1.2' 9"	1.8' 4"	2.4' 2-3/4"	3.2' 1-7/8"
2"	1' str.	1.5' 6-5/8"	2.2' 3-3/4"	2.8' 2-7/8"	3.9' 2"

Step 3: Calculate the Exact Heating Cable Length You Need

Multiply the cable length required per foot of pipe by the length of your pipe. Add one extra foot for each valve located in your line. Maximum cable length is 75 feet. For cable lengths longer than 75 feet, use two cables.

$$\begin{aligned} & (\text{Cable length required per foot of pipe} \times \text{pipe length}) \\ & + \text{one foot for each valve or spigot} \end{aligned}$$

= total cable length

Example

- You Have: 12 feet of plastic pipe length
1 ball valve
- You Need: 2.5 feet of cable per foot of plastic pipe as determined in Step 2 above.
- Calculate: (12 ft x 2.5) + 1 foot for ball valve
Total cable length = 31 ft

Maximum cable length is 75 feet. Use of longer length may cause the internal fuse to blow.

EasyHeat™ Freeze Free™ Cable

Pipe Freeze Protection, Self-Regulating, Cut-to-Length. For Residential Applications.

Product Selection

Catalog Number	Description	Carton Quantity	Carton Weight lb (kg)	UPC
2102	100 ft (30.48 m) reel Freeze Free	1	5 (2.3)	01362706895
2302	300 ft (91.44 m) reel Freeze Free	1	13 (5.9)	01362706896
2502	500 ft (152.40 m) reel Freeze Free	1	20 (9.1)	01362706894
10802	Connection kit – clam shell package	10	3 (1.4)	01362710802
10803	Connection kit – polybagged package	25	5 (2.3)	01362710803
10805	5 ft (1.52 m) pre-packaged Freeze Free kit	5	4 (1.8)	01362710805
10815	15 ft (4.57 m) pre-packaged Freeze Free kit	5	6 (2.7)	01362710815
4102	100 ft (30.48 m) display: (1) reel; (10) 10802	1	8 (3.6)	01362706897
4302	300 ft (91.44 m) display: (1) reel; (20) 10802; (10) EH38; (10) HCA	1	17 (7.7)	01362706898
NPRO50	50 ft (15.24 m) pro pack: (1) reel; (3) 10803; (1) HCA	1	3 (1.4)	01362710798
NPRO100	100 ft (30.48 m) pro pack: (1) reel; (6) 10803; (1) HCA	1	6 (2.7)	01362710799

PIPE TRACING

EasyHeat™ Freeze Free™ Cable Accessories

Pipe Freeze Protection. For Residential Applications.

Product Overview

- Freeze Free accessories are designed to integrate seamlessly with your FreezeFree self-regulating pipe heating cables.

EH38 Pre-Set Thermostat

- The EH38 pre-set thermostat automatically energizes the heating cable at temperatures lower than +38 °F (+3 °C) and turns off at +50 °F (+10 °C).
- Power indicator light confirms that power is flowing to the cable.
- Eliminates the need for unplugging heating cables each spring, and reduces the risk of frozen pipes.
- Controls other electrical devices that need to be activated when the temperature approaches the freezing point.
- Rated at 15 Amps, with load at 125 Vac; recommended for continuous loads at 8 Amps or less.
- One year limited warranty.



EH38 Pre-Set Thermostat



HCA Application Tape

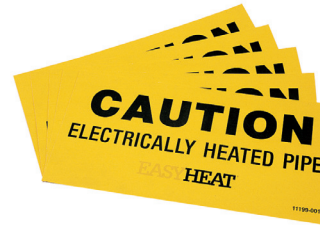

CS Caution Labels

HCA Application Tape

- The HCA application tape is the best tape to use with Freeze Free cable.
- 30 ft (9.14 m) of clear tape, rated for temperature so as not to lose its adhesive properties, and is printed with the words *ELECTRICALLY HEATED PIPE* for easy identification.
- Packaged one per carton and measures 0.5 in x 30 ft (1.27 cm x 9.14 m).
- One year limited warranty.

CS Caution Labels

- CS caution labels reduce the possibility of accidents and liability with easy-to-read caution labels.
- Labels are packaged five per bag.
- One year limited warranty.

Certifications

- EH38 Pre-Set Thermostat is UL Listed to US and Canadian Safety Standards, E225952.

Product Selection

Catalog Number	Description	Carton Quantity	Carton Weight lb (kg)	UPC
EH38	Pre-set thermostat	10	3 (1.3)	013627099388
HCA	Application tape: 0.5 in x 30 ft (1.27 cm x 9.14 m)	10	2 (0.9)	013627069459
CS	Heated pipe caution labels, 5 per bag	1	0.3 (0.1)	013627099241
FFEC	End seals – 5 per bag	10	2 (0.9)	013627069466

EasyHeat™ HB Cable

Pipe Freeze Protection, Constant Wattage, Hard-wired Cable. For Commercial Applications.

Product Overview

- The HB heating cable is complete with cold lead and ready for hard-wired installation on metal pipes to prevent freezing.

Applications

- Suitable for outdoor installation for refrigeration, condensation and air conditioning lines that are subject to freezing temperatures.

Features

- 120 Vac operating voltage.
- Keeps water flowing at ambient temperatures down to -40 °F (-40 °C).
- Includes ground braid, a black outer jacket, and a 2 ft (0.61 m) orange 14/3 cold lead with no thermostat or plug.
- Cables are rated at 7 Watts per foot (0.30 m).
- One year limited warranty.

Certifications

- UL Listed and CSA Certified to Canadian Safety Standards.

Notes

- Per NEC and CEC requirements ALWAYS use a ground fault protection device (GFEP) to reduce the danger of fire from a damaged or improperly installed heating cable. Electrical fault currents caused by damaged or improperly installed cable MAY NOT BE LARGE ENOUGH to trip a conventional circuit breaker.
- Heating cables must be installed in compliance with all national, state/provincial and local codes. Check with your local electrical inspector for specific details.
- Use on metal water pipes only. Do not use on plastic pipes.
- For outdoor use only. Do not use inside any type of building.
- The ambient temperature must be at least +15 °F (-10 °C) when attaching the cable to the pipe.
- This cable does not have an integral thermostat and must be controlled by a separately connected thermostat or by continuous monitoring of a qualified individual.

Product Selection

Catalog Number	Description	Amps	Carton Quantity	Carton Weight lb (kg)	UPC
HB01	3.28 ft (1 m) length, 23 Watts	0.19	20	10 (4.5)	06999600332
HB02	6.56 ft (2 m) length, 46 Watts	0.38	20	12 (5.4)	06999600333
HB03	9.84 ft (3 m) length, 69 Watts	0.58	20	15 (6.8)	06999600334
HB04	13.12 ft (4 m) length, 92 Watts	0.77	20	17 (7.7)	06999600335
HB05	16.41 ft (5 m) length, 115 Watts	0.96	20	20 (9.1)	06999600336
HB06	19.69 ft (6 m) length, 138 Watts	1.15	20	24 (10.9)	06999600337
HB07	22.97 ft (7 m) length, 161 Watts	1.34	10	13 (5.9)	06999600338
HB09	29.53 ft (9 m) length, 207 Watts	1.73	10	15 (6.8)	06999600339
HB12	39.37 ft (12 m) length, 275 Watts	2.29	10	17 (7.7)	06999600340
HB18	59.05 ft (18 m) length, 414 Watts	3.45	10	18 (8.2)	06999600341
HB24	78.74 ft (24 m) length, 551 Watts	4.59	10	21 (9.5)	06999600342



EasyHeat™ HB2 Cable

Pipe Freeze Protection, Constant Wattage, Hard-wired Cable. For Commercial Applications.

Product Overview

- The HB2 heating cable is complete with cold lead and ready for hard-wired installation on metal pipes to prevent freezing.

Applications

- Suitable for outdoor installation for refrigeration, condensation and air conditioning lines that are subject to freezing temperatures.

Features

- 240 Vac operating voltage.
- Keeps water flowing at ambient temperatures down to -40 °F (-40 °C).
- Includes ground braid, a black outer jacket, and a 2 ft (0.61 m) orange 14/3 cold lead with no thermostat or plug.
- Cables are rated at 7 Watts per foot (0.30 m).
- One year limited warranty.

Certifications

- UL Listed and CSA Certified to Canadian Safety Standards.

Notes

- Per NEC and CEC requirements ALWAYS use a ground fault protection device (GFEP) to reduce the danger of fire from a damaged or improperly installed heating cable. Electrical fault currents caused by damaged or improperly installed cable MAY NOT BE LARGE ENOUGH to trip a conventional circuit breaker.
- Heating cables must be installed in compliance with all national, state/provincial and local codes. Check with your local electrical inspector for specific details.
- Use on metal water pipes only. Do not use on plastic pipes.
- For outdoor use only. Do not use inside any type of building.
- The ambient temperature must be at least +15 °F (-10 °C) when attaching the cable to the pipe.
- This cable does not have an integral thermostat and must be controlled by a separately connected thermostat or by continuous monitoring of a qualified individual.



PIPE TRACING

Product Selection

Catalog Number	Description	Amps	Carton Quantity	Carton Weight lb (kg)	UPC
HB022	6.56 ft (2 m) length, 46 Watts	0.19	20	13 (5.9)	06999600343
HB042	13.12 ft (4 m) length, 92 Watts	0.38	20	17 (7.7)	06999600344
HB062	19.69 ft (6 m) length, 138 Watts	0.58	20	21 (9.5)	06999600345
HB082	26.25 ft (8 m) length, 184 Watts	0.77	10	14 (6.4)	06999600346
HB102	32.81 ft (10 m) length, 230 Watts	0.96	10	17 (7.7)	06999600347
HB122	39.37 ft (12 m) length, 275 Watts	1.15	10	21 (9.5)	06999600348
HB142	45.93 ft (14 m) length, 321 Watts	1.34	5	14 (6.4)	06999600349
HB182	59.06 ft (18 m) length, 414 Watts	1.73	5	15 (6.8)	06999600350
HB242	78.74 ft (24 m) length, 551 Watts	2.30	5	20 (9.1)	06999600351

EasyHeat™ PSR Cable

Pipe Freeze Protection, Self-Regulating, Pre-Terminated. For Residential and Commercial Applications.

Product Overview

- PSR is a parallel resistance, self-regulating cable provided in pre-terminated lengths with factory sealed connections.
- The self-regulating heating cable automatically varies its heat output as the surrounding temperature changes.

Applications

- Commercial and residential plastic or metal water supply and drain pipes subject to freezing.
- Suitable for refrigeration/HVAC condensation lines that are subject to freezing temperatures.
- Residential fuel lines.

Features

- 120 Vac and 240 Vac models available.
 - 120 Vac models have an integral three-wire plug with a pilot light.
 - 240 Vac models have a three wire pigtail.
- Cables are rated at 5 Watts per foot (0.30 m) at +50 °F (+10 °C).
- Pre-terminated lengths from 6 ft – 100 ft (1.83 m – 30.48 m).
- Manufactured with a waterproof TPE outer jacket.
- One year limited warranty.

Heating Cable Control Options and Power Connection

- 120 Vac cables should be plugged into a ground fault protected electrical receptacle.
- 240 Vac cables are designed to be directly connected into an appropriate electrical outlet box supplied by ground fault protected circuit.

Related Products

- It is recommended that a remote thermostat similar to EasyHeat model C3RC be used for 240 Vac cables to reduce energy consumption and extend the life of the cable. See *EasyHeat Pipe Tracing Controls*.

Accessories

- Installation tape and caution labels are available. See *EasyHeat Pipe Tracing Accessories*.



Certifications

- UL Listed to Canadian Safety Standards and CSA Certified for ordinary locations.

Notes

- Per NEC and CEC requirements ALWAYS use a ground fault protection device (GFEP) to reduce the danger of fire from a damaged or improperly installed heating cable. Electrical fault currents caused by damaged or improperly installed cable MAY NOT BE LARGE ENOUGH to trip a conventional circuit breaker.
- Heating cables must be installed in compliance with all national, state/provincial and local codes. Check with your local electrical inspector for specific details.
- Do not use thin 1/8 in (3.18 mm) foil-backed foam insulation.
- Before insulating, ensure that there is no damage to heating cables. Immediately cover the pipe, cables, connections, valves and spigots with 1/2 in (12.7 mm) to 1 in (25.4 mm) thick fiberglass insulation or equivalent.
- Do not alter the length of the heating cable — cable is factory sealed and alteration will result in risk of electrical fire or shock.
- Exposure to temperatures above +150 °F (+66 °C). will shorten the life of your cable. Before installing on hot water pipes, set the water heater thermostat below +150 °F (+66 °C).
- If more than one heating cable is used on a single electrical circuit please refer to the maximum heater length per circuit breaker size chart. Check to make sure the total heating cable length does not exceed the length specified in this table.
- Minimum installation temperature for the heating cable set is -22 °F (-30 °C).
- Do not use extension cords.

PIPE TRACING

Illustrated Features

Pilot Light

120 Vac models have a pilot light in the PSR plug, assures the system has power.

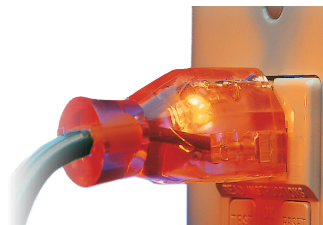

Three Wire Pigtail

240 Vac models have a three wire pigtail that should be directly connected into an appropriate electrical box supplied by ground fault protected circuit.



EasyHeat™ PSR Cable

Pipe Freeze Protection, Self-Regulating, Pre-Terminated. For Residential and Commercial Applications.

How To Determine The Length of Cable You Need

Select the appropriate cable length from one of the two charts below. Cable may be up to 2 ft (60.96 cm) shorter than the pipe. Lengths insert the non-breaking space here (control+alt+X) so that Lengths stays with assume. Lowest ambient temperature is -20 °F (-29 °C), with a minimum of 1/2 in (12.7 mm) fiberglass insulation or equivalent. For protection to -40 °F (-40 °C), use 1 in (25.4 mm) fiberglass insulation.

Cable Length Selection Chart

Metal Pipe ft (m)										
Pipe Diameter in (mm)	3 (0.91)	4-6 (1.2-1.83)	7 (2.13)	8-12 (2.44-3.66)	13-14 (3.96-4.27)	15-18 (4.57-5.49)	19-25 (5.79-7.62)	26-50 (7.92- 15.24)	51-75 (15.54- 22.86)	76-100 (21.16-30.48)
0.5 (12.7)	—	A	A	B	B	C	C	E	F	G
1.0 (25.4)	A	A	A	B	B	C	C	E	F	G
1.5 (38.1)	A	A	A	B	B	C	D	E	F	G
2.0 (50.8)	A	B	B	C	C	D	E	F	G	H
2.5 (63.5)	A	B	B	C	C	D	E	F	G	H

Plastic Pipe ft (m)										
Pipe Diameter in (mm)	3 (0.91)	4-6 (1.2-1.83)	7 (2.13)	8-12 (2.44-3.66)	13-14 (3.96-4.27)	15-18 (4.57-5.49)	19-25 (5.79-7.62)	26-50 (7.92-15.24)	51-75 (15.54- 22.86)	76-100 (21.16-30.48)
0.5 (12.7)	—	A	B	B	C	D	D	E	F	G
1.0 (25.4)	A	A	B	C	C	D	E	E	F	G
1.5 (38.1)	A	B	C	D	D	E	E	F	F	H
2.0 (50.8)	A	B	C	E	E	E	E	F	G	H
2.5 (63.5)	A	B	C	E	E	E	F	F	G	H

Maximum Cable Length per Circuit in ft (m)

Breaker Size	120 Vac Cable			240 Vac Cable		
	+20 °F (-7 °C)	0 °F (-20 °C)	-20 °F (-30 °C)	+20 °F (-7 °C)	0 °F (-20 °C)	-20 °F (-30 °C)
15 Amp	125 (38.1)	115 (35.1)	100 (30.5)	250 (76.2)	225 (68.6)	205 (62.5)
20 Amp	170 (51.8)	150 (45.7)	135 (41.1)	335 (102.1)	300 (91.4)	270 (82.3)

Selection Chart Key

	Model #	# of Cables
A	PSR (Ⓞ)006	1 Cable
B	PSR (Ⓞ)012	1 Cable
C	PSR (Ⓞ)018	1 Cable
D	PSR (Ⓞ)024	1 Cable
E	PSR (Ⓞ)050	1 Cable
F	PSR (Ⓞ)075	1 Cable
G	PSR (Ⓞ)100	1 Cable
H	PSR (Ⓞ)100	2 Cable

Replace Ⓞ with voltage code: 1 for 120 Vac; 2 for 240 Vac.

Note: Allow an extra 1 ft (30.48 cm) of heating cable for each valve.

PIPE TRACING

EasyHeat™ PSR Cable

Pipe Freeze Protection, Self-Regulating, Pre-Terminated. For Residential and Commercial Applications.

Product Selection

Catalog Number	Description	Carton Quantity	Carton Weight lbs (kg)	UPC
PSR1006	6 ft (1.83 m) length, 30 Watts, 120 Vac	5	4 (1.8)	01362706907
PSR1012	12 ft (3.66 m) length, 60 Watts, 120 Vac	5	7 (3.2)	01362706908
PSR1018	18 ft (5.49 m) length, 90 Watts, 120 Vac	5	8 (3.6)	01362706913
PSR1024	24 ft (7.32 m) length, 120 Watts, 120 Vac	5	10 (4.5)	01362706909
PSR1050	50 ft (15.24 m) length, 250 Watts, 120 Vac	5	17 (7.7)	01362706910
PSR1075	75 ft (22.86 m) length, 375 Watts, 120 Vac	2	10 (4.5)	01362706911
PSR1100	100 ft (30.48 m) length, 500 Watts, 120 Vac	2	13 (5.9)	01362706912
PSR2006	6 ft (1.83 m) length, 30 Watts, 240 Vac	5	4 (1.8)	01362706867
PSR2012	12 ft (3.66 m) length, 60 Watts, 240 Vac	5	7 (3.2)	01362706868
PSR2018	18 ft (5.49 m) length, 90 Watts, 240 Vac	5	9 (4.1)	01362706873
PSR2024	24 ft (7.32 m) length, 120 Watts, 240 Vac	5	10 (4.5)	01362706869
PSR2050	50 ft (15.24 m) length, 250 Watts, 240 Vac	5	16 (7.3)	01362706870
PSR2075	75 ft (22.86 m) length, 375 Watts, 240 Vac	2	9 (4.1)	01362706871
PSR2100	100 ft (30.48 m) length, 500 Watts, 240 Vac	2	13 (5.9)	01362706872

EasyHeat™ SR Trace™ Cable

Pipe Freeze Protection and Temperature Maintenance, Self-Regulating, Cut-to-Length.

For Residential and Commercial Applications.

Product Overview

- SR Trace cable is a self-regulating heating cable that provides maximum freeze protection and maintains temperatures for supply and drain pipes and vessels.
- The self-regulating heating cable automatically varies its heat output as the surrounding temperature changes.

Applications

- Commercial plastic or metal water supply and drain pipes subject to freezing.
- Liquids piped during processing that require constant temperatures.
- Freeze protection for main and branch sprinkler systems.
- Suitable for refrigeration/HVAC condensation lines that are subject to freezing temperatures.

Features

- Maximum freeze protection for pipes and vessels in ambient temperatures down to -40 °F (-40 °C).
- Freeze protection for plastic or metal pipes up to 36 in (30.32 cm) in diameter.
- Available in power densities of 3, 5, and 8 Watts per foot (0.30 m) at +50 °F (+10 °C) for both 120 and 240 Vac applications.
- 240 Vac can be used for 208 or 277 Vac applications.
- Available in cut-to-order lengths, convenient 250 ft (76.20 m) self dispensing reel boxes and 750 ft (228.6 m) master supply reels.
- Manufactured with a waterproof TPE outer jacket.
- Can be installed in dry or wet environments.
- Can be wrapped over itself (overlapped), if necessary, when installed on pipes, valves or flanges.
- One year limited warranty.

Related Products

- It is recommended that heating cables for freeze protection be controlled by a thermostat to minimize energy consumption.

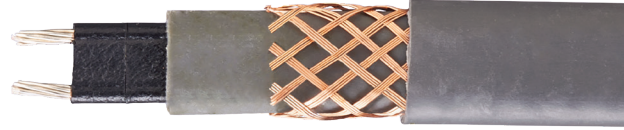

See *EasyHeat Pipe Tracing Controls*. Control options available:
— T4XA Thermostat
— C4XC Thermostat
— C3RC Thermostat

Accessories

- We offer specially designed kits that ease installation and connection of SR Trace products. See *EasyHeat SR Trace Cable Connection Kits and Accessories*.

Certifications

- UL listed and CSA certified to US and Canadian Safety Standards.

Note:

- Per NEC and CEC requirements ALWAYS use a ground fault protection device (GFEP) to reduce the danger of fire from a damaged or improperly installed heating cable. Electrical fault currents caused by damaged or improperly installed cable MAY NOT BE LARGE ENOUGH to trip a conventional circuit breaker.
- Heating cables must be installed in compliance with all national, state/provincial and local codes. Check with your local electrical inspector for specific details.
- Do not twist the bus wires together at either end of the cable.
- It is recommended that all heat traced pipes have a minimum of 1/2 in (12.7 mm) of fiberglass insulation or equivalent.
- All electrical connections in the system should be sealed against moisture.
- Do not expose heating cables to temperatures above their maximum ratings.

PIPE TRACING

Illustrated Features

A special self-regulating core is at the center of the SR Trace cable. This core is conductive and adjusts according to the surrounding temperatures. When it is cold, the cable's core has many conductive paths that generate enough heat to keep the water flowing in the pipe. As the surrounding temperature warms, there are fewer conductive paths and less heat is generated.

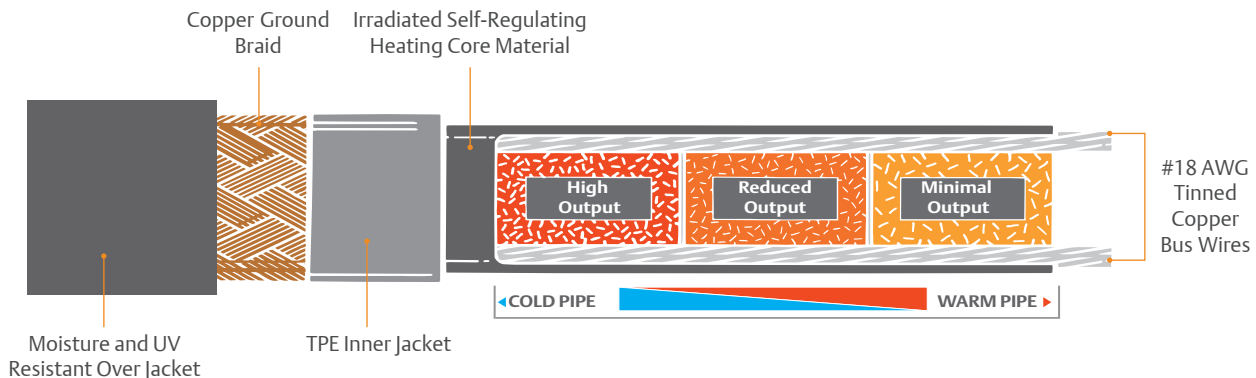

EasyHeat™ SR Trace™ Cable

Pipe Freeze Protection and Temperature Maintenance, Self-Regulating, Cut-to-Length.
For Residential and Commercial Applications.

How To Determine The Length of Cable You Need

Typical Installation

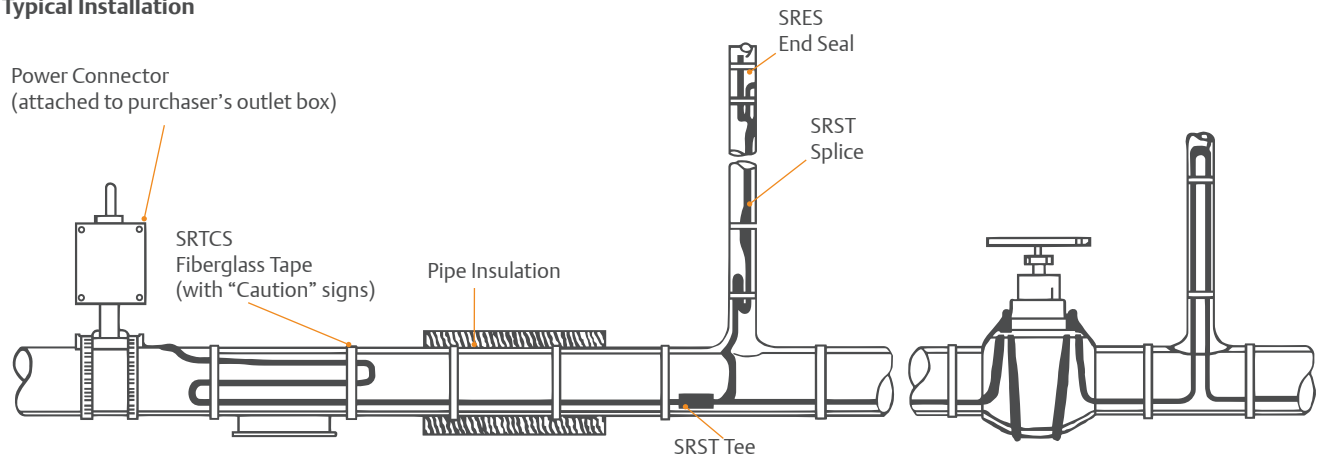

Step 1: Planning

Determine the following information to enable proper selection of heating cable:

- Pipe diameter
- Pipe length
- Pipe material
- Minimum ambient temperature
- Type of insulation
- Thickness of insulation
- Number of flanges, pipe supports, shoes, etc.
- Power supply voltage
- Number of valves

Step 2: Cable Selection

Using the information from Step 1, select the appropriate heating cable type and number required from Table 1: Pipe Freeze Protection.

Step 3: Determine Cable Length

Total Cable Length = [Number of Cables (see Table 1) x Pipe Length]
+ (4 ft x Number of Valves)
+ (2 ft x Number of Flanges/Supports, etc.)

Example:

- Pipe Diameter: 3 inches
- Pipe Length: 105 ft
- Pipe Material: Steel
- Minimum Ambient Temperature: -10 °F (-23 °C)
- Type of Insulation: Fiberglass
- Thickness of Insulation: 1 inch
- Flanges, Supports, etc.: None
- Power Supply Voltage: 120 Vac
- Number of Valves: 3

Example: SR51J Cable Length:

$(1 \times 105 \text{ ft}) + (4 \text{ ft} \times 3 \text{ valves}) + (2 \text{ ft} \times 0) = 117 \text{ ft}$

Step 4: Power Supply Requirements

The total length of the heating cable installed on any circuit must not exceed the "Maximum Total Cable Length" associated with the circuit breaker supplying the circuit, see Table 2. If total length of heating cable required does exceed that allowed for the circuit breaker supplying the circuit, either a larger circuit breaker (and associated wiring) must be used, or multiple circuit breakers (and associated wiring) must be installed. From Table 2: Circuit Breaker Selection, determine the number of circuits and circuit breaker size required to supply the heating cables.

Step 5: Cable Routing

From the piping arrangement, determine the length of the longest single run of cable. If this value exceeds the "Maximum Length Single Run" found in Table 3. Performance and Rating Data, then the cable routing, or type of cable selected, must be altered. Also, 240 Vac cables allow longer single runs than 120 Vac cables.

EasyHeat™ SR Trace™ Cable

Pipe Freeze Protection and Temperature Maintenance, Self-Regulating, Cut-to-Length.

For Residential and Commercial Applications.

Table 1. Pipe Freeze Protection

Legend: A = SR31J (120V) or SR32J (240 or 277V) | B = SR51J (120V) or SR52J (240 or 277V) | C = SR81J (120V) or SR82J (240 or 277V)

Pipe Diameter in (mm)	Insulation Thickness in (mm)	Minimum Ambient Temperature							
		+14 °F (-10 °C)		-4 °F (-20 °C)		-22 °F (-30 °C)		-40 °F (-40 °C)	
		Metal Pipe	Plastic Pipe	Metal Pipe	Plastic Pipe	Metal Pipe	Plastic Pipe	Metal Pipe	Plastic Pipe
1/2 (12.70)	0.5 (12.70)	A	A	A	A	A	B	B	C
3/4 (19.05)		A	A	A	B	B	B	B	C
1 (25.40)		A	A	A	B	B	C	B	C
1-1/4 (31.75)		A	A	A	B	B	C	B	C
1-1/2 (38.10)		A	A	B	C	B	2B	C	2C
2 (50.80)		A	B	B	C	C	2B	C	2C
2-1/2 (63.50)		A	B	B	C	C	2C	2B	2C
3 (76.20)		B	B	B	2B	Ⓢ	2C	2C	Ⓢ
4 (101.60)		B	B	C	2C	Ⓢ	Ⓢ	2C	Ⓢ
6 (152.40)		B	2B	2B	Ⓢ	Ⓢ	Ⓢ	Ⓢ	Ⓢ
1/2 (12.70)	1 (25.40)	A	A	A	A	A	A	A	B
1 (25.40)		A	A	A	A	A	B	A	B
1-1/2 (38.10)		A	A	A	B	A	B	B	C
2 (50.80)		A	A	A	B	B	C	B	C
2-1/2 (63.50)		A	A	A	B	B	C	C	2B
3 (76.20)		A	A	B	C	B	C	C	2B
4 (101.60)		A	B	B	C	C	2B	C	2C
6 (152.40)		B	B	C	2B	C	2C	2C	Ⓢ
8 (203.20)		B	Ⓢ	C	2C	2B	Ⓢ	2C	Ⓢ
1-1/2 (38.10)		1.5 (38.10)	A	A	A	A	A	B	A
2 (50.80)	A		A	A	A	A	B	B	C
4 (101.60)	A		A	A	B	B	C	C	2B
6 (152.40)	A		B	B	C	C	2B	C	2C
8 (203.20)	A		Ⓢ	B	2B	C	2C	2B	Ⓢ
2 (50.80)	2 (50.80)	A	A	A	A	A	B	A	B
4 (101.60)		A	A	A	B	B	C	B	C
6 (152.40)		A	A	B	C	B	C	C	2B
8 (203.20)		A	Ⓢ	B	C	C	2B	C	2C
4 (101.60)	3 (76.20)	A	A	A	A	A	B	A	B
6 (152.40)		A	A	A	A	A	B	B	B
8 (203.20)		A	Ⓢ	A	Ⓢ	B	Ⓢ	B	Ⓢ

PIPE TRACING

① For operation at 208 Volts, use the cable recommended for the next colder minimum ambient temperature. For example, to protect a 2-1/2 in (63.50 mm) metal pipe with 1/2 in (12.70 mm) insulation to +14 °F (-10 °C), use the value found under -4 °F (-20 °C) column, resulting an SR52J cable.

② Contact your local EasyHeat sales representative for cable selection.

EasyHeat™ SR Trace™ Cable

Pipe Freeze Protection and Temperature Maintenance, Self-Regulating, Cut-to-Length.
For Residential and Commercial Applications.

Circuit Breaker Selection ①

Voltage	Cable Power Watts/ft (Watts/m)	Minimum Start-up Temperature °F (°C)	Maximum Total Cable Length vs. Circuit Breaker Rating ft (m)		
			15A ③	20A	30A
120	3 (10)	-40 (-40)	170 (51)	226 (69)	340 (103)
		0 (-18)	210 (64)	280 (85)	420 (128)
		+40 (+4)	270 (82)	360 (110)	540 (165)
	5 (16)	-40 (-40)	123 (37)	163 (49)	245 (74)
		0 (-18)	155 (47)	205 (63)	320 (98)
		+40 (+4)	195 (59)	255 (78)	385 (117)
	8 (26)	-40 (-40)	86 (26)	115 (35)	173 (52)
		0 (-18)	105 (32)	140 (43)	210 (64)
		+40 (+4)	135 (41)	180 (55)	270 (82)
240	3 (10)	-40 (-40)	340 (103)	473 (138)	679 (207)
		0 (-18)	420 (128)	555 (169)	835 (255)
		+40 (+4)	540 (165)	720 (220)	1080 (329)
	5 (16)	-40 (-40)	245 (74)	327 (99)	490 (149)
		0 (-18)	310 (95)	415 (127)	620 (189)
		+40 (+4)	385 (117)	515 (157)	770 (235)
	8 (26)	-40 (-40)	173 (52)	231 (70)	346 (105)
		0 (-18)	210 (64)	280 (85)	425 (130)
		+40 (+4)	270 (82)	360 (110)	540 (165)

Performance and Rating Data

Catalog Number	Voltage	Power Rating Watts/ft (Watts/m) @ +50 °F (+10 °C)	Maximum Length Single Run ft (m)
SR31J	120	3 (10)	310 (94)
SR32J	240	3 (10)	620 (188)
SR51J	120	5 (16)	240 (73)
SR52J	240	5 (16)	480 (146)
SR81J	120	8 (26)	190 (58)
SR82J	240	8 (26)	380 (116)

Maximum maintenance temperature, all cables: +150 °F (+66 °C).

Maximum intermittent exposure temperature, all cables: +185 °F (+85 °C).

Voltage Adjustment Table ②

Cable	Power Rating Multiplier		
	208 Vac	240 Vac	277 Vac
SR32J	0.71	1.00	1.34
SR52J	0.80	1.00	1.20
SR82J	0.87	1.00	1.12

Note:

① Circuit breakers are sized per article 427-4 of NEC and CSA/CEC 62-114.

② To operate 240 Vac cables at 208 Vac or 277 Vac, the cable power is modified by the "power rating multiplier" in the voltage adjustment table. The maximum total lengths on a circuit breaker (circuit breaker selection table) and the maximum single run lengths (performance and rating data table) do not change.

③ When using two (2) or more heating cables of different wattage ratings in parallel on a single circuit breaker, use the 15A column amperage of 15 amps, divide it by the maximum footage to arrive at an amps/ft figure for each cable. Then calculate circuit breaker size for the combined loads. These amps/ft factors include the sizing factor in (1) above.

Nominal Power Output on Metal Pipe

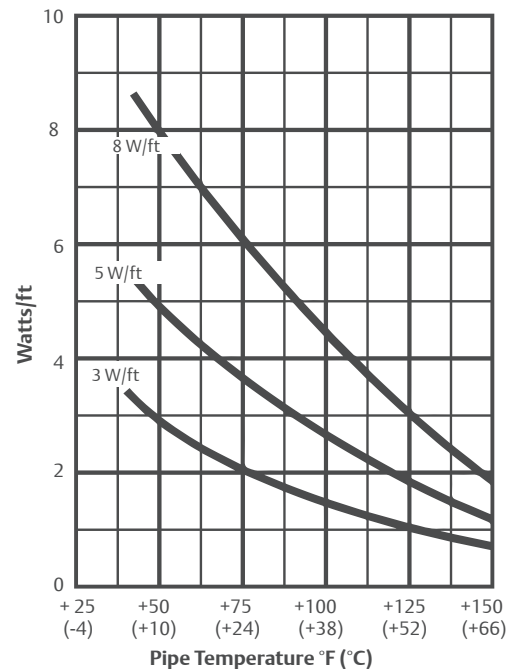

EasyHeat™ SR Trace™ Cable

Pipe Freeze Protection and Temperature Maintenance, Self-Regulating, Cut-to-Length.
For Residential and Commercial Applications.

Product Selection

Catalog Number	Description	Carton Quantity	Carton Weight lb (kg)	UPC
SR31J	3 Watts per foot (0.30 m), 120 Vac, cut-to-order	1	0.057 (0.026) per foot	01362700302
SR31J250	250 ft (76.20 m) self-dispensing reel	1	20 (9.1)	01362706925
SR32J	3 Watts per foot (0.30 m), 240 Vac, cut-to-order	1	0.057 (0.026) per foot	01362700189
SR32J250	250 ft (76.20 m) self-dispensing reel	1	20 (9.1)	01362706923
SR51J	5 Watts per foot (0.30 m), 120 Vac, cut-to-order	1	0.057 (0.026) per foot	01362700877
SR51J250	250 ft (76.20 m) self-dispensing reel	1	20 (9.1)	01362706921
SR51J750	750 ft (228.60 m) self-dispensing reel	1	72 (32.7)	01362706926
SR52J	5 Watts per foot (0.30 m), 240 Vac, cut-to-order	1	0.057 (0.026) per foot	01362701021
SR52J250	250 ft (76.20 m) self-dispensing reel	1	20 (9.1)	01362706919
SR52J750	750 ft (228.60 m) self-dispensing reel	1	72 (32.7)	01362706924
SR81J	8 Watts per foot (0.30 m), 120 Vac, cut-to-order	1	0.057 (0.026) per foot	01362700192
SR81J250	250 ft (76.20 m) self-dispensing reel	1	20 (9.1)	01362706917
SR81J750	750 ft (228.60 m) self-dispensing reel	1	72 (32.7)	01362706918
SR82J	8 Watts per foot (0.30 m), 240 Vac, cut-to-order	1	0.057 (0.026) per foot	01362700164
SR82J250	250 ft (76.20 m) self-dispensing reel	1	20 (9.1)	01362706915
SR82J750	750 ft (228.60 m) self-dispensing reel	1	72 (32.7)	01362706916

PIPE TRACING

EasyHeat™ SR Trace™ Cable Connection Kits and Accessories

Pipe Freeze Protection and Temperature Maintenance. For Residential and Commercial Applications.

Product Overview

- SR Trace pipe tracing self-regulating heating cables must be installed with appropriate connection kits.

EHES Push-On End-Seal Kit

- Terminates end of all 3, 5, 8 Watt SR Trace heating cables.
- Easy push-on design allows for quick installation, forming a permanent connection.
- Used without heating gun for portability on any job site.
- Indoor/Outdoor approved for dry/wet Pipe Trace applications.
- Kit includes two (2) end seals.



EHES Push-On End-Seal Kit

SRP Power/Splice Connection Kit

- Provides heat shrink tubing based power connection for one or two cables within customer supplied junction box.
- Provides heat shrinkable end seals.
- Can be used for heating cable to heating cable splice using a customer supplied junction box.
- One year limited warranty.



SRP Power/Splice Connection Kit

SRST In-line Splice Connection Kit

- Provides heat shrink tubing based in-line splice connection of two or three heating cables.
- Each kit performs two sets of splices and junction box is not required.
- One year limited warranty.



SRST In-line Splice Connection Kit

SRES End Seal Kit

- Provides heat shrink tubing to create a moisture proof end seal of the heating cable circuit.
- Each kit contains 5 end seals.
- One year limited warranty.



SRES End Seal Kit

SRTCS

- 3/4 in x 66 ft (0.019 m x 20.17 m) of fiberglass tape and five "caution" signs for compliance with NEC 427-13.
- One year limited warranty.



SRTCS

SRME End Seal Kit

- Used for terminating the ends of field-fabricated heating cables.
- Constructed of molded silicone material molded silicone material and silicone adhesive.
- Each kit contains materials to make 5 complete terminations.
- One year limited warranty.



SRME End Seal Kit

SRMP Power End Connection Kit

- Used for terminating field-fabricated heating cables inside the power connection box.
- Constructed of molded silicone material molded silicone material and silicone adhesive.
- Each kit contains materials to make 5 complete connections.
- One year limited warranty.



SRMP Power End Connection Kit

GFST1 Line Plug

- Plug in power connection kit with ground fault circuit protection.
- 3 ft (0.91 m) long assembly, rated for 15 Amp circuit breaker at 120 Vac.
- Includes two heat shrinkable end-seals.
- One year limited warranty.



GFST1

① Agency approvals are only valid when appropriate kits are used to install the heating cable for the appropriate heating application.

EasyHeat™ SR Trace™ Cable Connection Kits and Accessories

Pipe Freeze Protection and Temperature Maintenance. For Residential and Commercial Applications.

Certifications

- The EHES Push-On End-Seal kit and GFST1 Line Plug are UL listed to both US and Canadian standards.
- SRP power/splice connection kits, SRST in-line splice connection kits, SRES end seal kits are UL Listed and CSA Certified. ①
- SRME end seal kits and SRMP power end connection kits are UL Listed, CSA Certified and Factory Mutual Approved for use in Class I, Division 2 locations.

Product Selection

Catalog Number	Description	Carton Quantity	Carton Weight lb (kg)	UPC
EHES	Push-On End-Seal kit	1	2 (0.9)	013627005662
SRP	Heat shrink power/end connection kit	5	3 (1.4)	01362706972
SRST	Heat shrink splice and “T” connection kit	2	2 (0.9)	01362706959
SRES	Heat shrink end seal kit	5	2 (0.9)	01362706968
SRTCS	Fiberglass application tape and caution signs	1	2 (0.9)	01362706970
SRME	End Seal Termination Kit	1	0.4 (0.2)	01362700157
SRMP	Power End Termination Kit	1	0.4 (0.2)	01362700155
GFST1	GFCI line plug to heating cable, 120 Vac rated	1	1 (0.5)	01362706965
SRPC ②	Heat shrink power/end connection kit	5	3 (1.4)	01362706972

PIPE TRACING

① Agency approvals are only valid when appropriate kits are used to install the heating cable for the appropriate heating application.

② Available exclusively for Canada.

EasyHeat™ TSR Cable

Pipe Freeze Protection and Pipe Temperature Maintenance, Self-Regulating, Cut-to-Length. For Commercial Applications.

Product Overview

- TSR self-regulating cable maintains liquids in pipes at a constant temperature to prevent freezing or degradation of the liquid or to maintain viscosity for flow conditions.
- The self-regulating heating cable automatically varies its heat output as the surrounding temperature changes.

Applications

- TSR cable can be used for commercial pipe freeze protection or temperature maintenance applications, in either ordinary or hazardous (Class I, Division 2) locations.
- Suitable for refrigeration/HVAC condensation lines that are subject to freezing temperatures.

Features

- Available for 120, 208, 240, and 277 Vac applications.
- Available in circuit lengths up to 650 ft (198.12 m) and wattages up to 10 Watts per foot (0.30 m) at +50 °F (+10 °C).
- Parallel resistance, cut-to-length cable is provided on bulk spools.
- Can be wrapped over itself (overlapped), if necessary, when installed on pipes, valves or flanges.
- TSR cable is also available with fluoropolymer overjacket for use in areas requiring enhanced chemical resistance.
 - TSR cable with fluoropolymer overjacket is suitable for maintaining grease and fuel lines at temperatures required for viscosity maintenance.
- One year limited warranty.

Accessories

- We offer specially designed kits that ease installation and connection of TSR products. See *EasyHeat TSR Connection Kits and Accessories*.

Related Products

- It is recommended that heating cables for freeze protection and temperature maintenance applications be controlled by a thermostat to optimize energy consumption. See *EasyHeat Pipe Tracing Controls*. Control options are as follows:

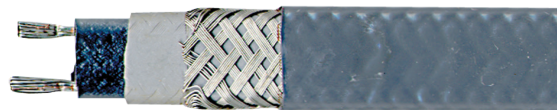

- Ordinary Areas
 - C4XC Thermostat
 - T4XC Thermostat
 - T4XA Thermostat
- Hazardous Locations Areas
 - T9EC Thermostat
 - T9EA Thermostat

Certifications

- UL Listed, CSA Certified and Factory Mutual Approved for use in Class I, Division 2 Hazardous Locations with a T5 Temperature rating, when used with approved termination accessories.

Notes

- Per NEC and CEC requirements ALWAYS use a ground fault protection device (GFPE) to reduce the danger of fire from a damaged or improperly installed heating cable. Electrical fault currents caused by damaged or improperly installed cable MAY NOT BE LARGE ENOUGH to trip a conventional circuit breaker.
- Heating cables must be installed in compliance with all national, state/provincial and local codes. Check with your local electrical inspector for specific details.
- Do not twist the bus wires together at either end of the cable.
- Insulate black polymer surrounding bus wires.
- All electrical connections in the system must be sealed against moisture.
- It is recommended that all heat traced pipes have a minimum of 1/2 inch (12.7 mm) of fiberglass insulation or equivalent.
- Do not expose heating cables to temperatures above their maximum ratings.
- Immediately replace any damaged heating cable or components.
- Classified areas (explosive dust or gas) require the use of special electrical components.

Illustrated Features

A special self-regulating core is at the center of the TSR cable. This core is conductive and adjusts according to the surrounding temperatures. When it is cold, the cable's core has many conductive paths that generate enough heat to keep the water flowing in the pipe. As the surrounding temperature warms, there are fewer conductive paths and less heat is generated.

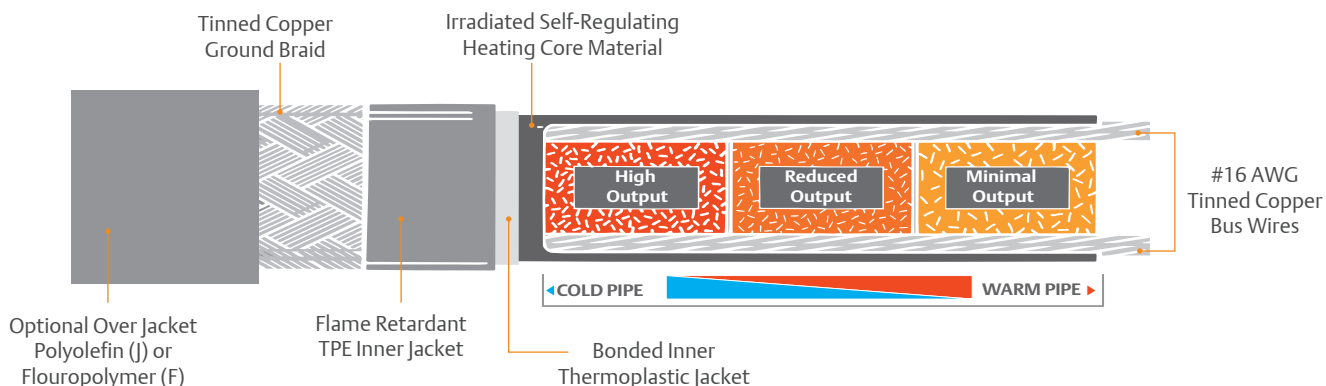

EasyHeat™ TSR Cable

Pipe Freeze Protection and Pipe Temperature Maintenance, Self-Regulating, Cut-to-Length. For Commercial Applications.

How To Determine The Length of Cable You Need

Typical Installation

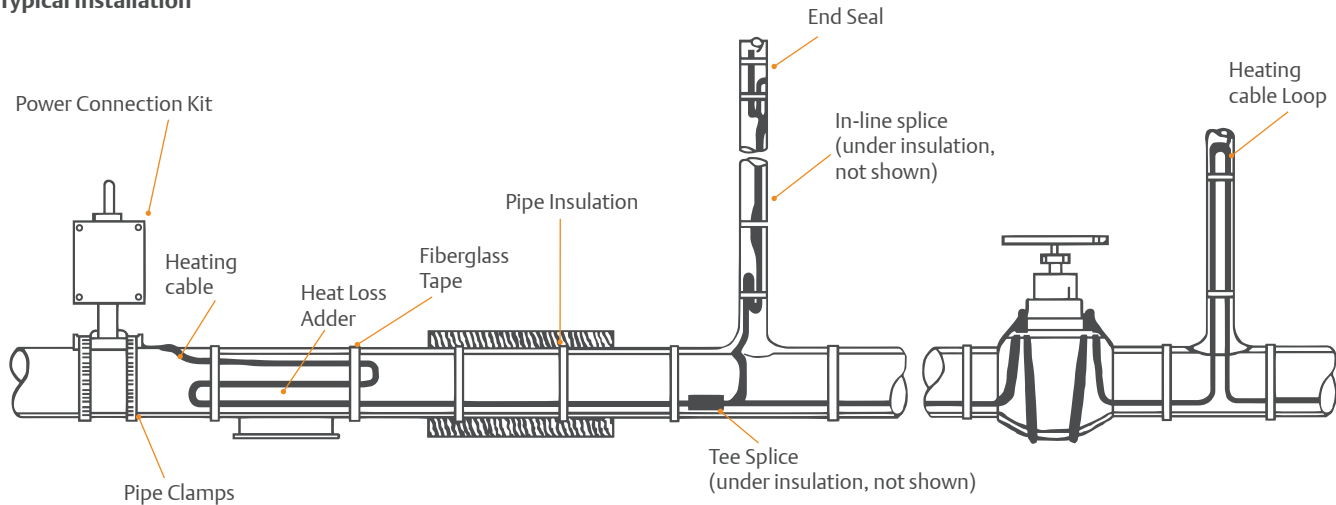

Please note that this installation is for ordinary (non-hazardous) locations

Design Procedure

The following procedure can be used to select a heating cable system for your application. To determine the heat loss that must be replaced by the heating cable, the following should be determined:

- T_F Fluid temperature to be maintained
- T_A Minimum ambient temperature
- Size and material of pipe to be heated
- Thermal insulation – type and thickness
- Pipe supports and valves, etc.

1. Temperature Differential

Determine the temperature differential (ΔT) to be maintained by subtracting the ambient temperature (T_A) from the fluid temperature (T_F) to be maintained ($\Delta T = T_F - T_A$). Typically, for pipe freeze protection applications, the pipe temperature should be maintained at +40 °F (+4 °C). Pipe temperatures should be maintained at +110 °F (+43 °C) for grease disposal lines and +40 °F (+4 °C) for fuel lines.

2. Heat Loss

Use Table 1. Pipe Heat Loss (W/ft), to look up the heat loss associated with the pipe diameter and thickness of insulation. If a rigid insulation such as calcium silicate is used, the pipe heat loss should be increased to that associated with the next larger size. Insulation should also be oversized when using any cable other than the standard self-regulating TSR, without over jacket. This will compensate for the space of the heating cable. As an example, you would use 2 in (50 mm) pipe diameter heat losses for 1-1/2 in (38 mm) pipe heating application if rigid insulation were used. Heat loss figures from Table 1 include a 10% safety factor.

3. Adjustments To Heat Loss Values

The heat loss values in Table 1 are based on glass fiber insulation. If other insulations are used, multiply the heat loss value by the correction factor for your insulation shown in Table 2: Insulation Factors.

4. Determine Cable Power

Using heat loss determined above, select appropriate cable from Performance and Rating Data chart. For heat loss in excess of 10 W/ft, use multiple cables. For example, for heat loss of 13 W/ft, use two 8 W/ft cables. Cable power may exceed heat loss by up to 50%. It is also possible to spiral cable on pipe such that the power applied to the pipe exactly matches the pipe heat loss. For example, for heat loss of 13 W/ft, a 10 W/ft cable can be spiraled on the pipe such that 1.3 ft (0.40 m) of cable are wound on every foot of pipe, resulting in exactly 13 W/ft being applied to the pipe. However, spiraling requires significant extra labor to install and significant clearance around the pipe. For this reason, we do not recommend spiraling. For further information on spiraling, contact your local EasyHeat sales representative.

5. Adjustments For Heat Sinks

Any thermally conductive item that protrudes through the insulation will require extra heat to be applied to the pipe. The footage shown in Table 3: Heat Loss Adder should be added to the required heating cable length to compensate for these extra heat losses. When multiple tracing or spiraling cable is necessary, increase the cable adders proportionately.

6. Determine Cable Length

Cable length = (pipe length \times N) + (heat sink adjustments \times N) + (slack \times N)

Slack = (2 ft for power supply) + (2 ft per tee) + (2 ft for tail end)

N = number of traces

EasyHeat™ TSR Cable

Pipe Freeze Protection and Pipe Temperature Maintenance, Self-Regulating, Cut-to-Length.
For Commercial Applications.

Table 1: Pipe Heat Loss, W/ft

Insulation Thickness in (mm)	ΔT °F (°C)	Pipe Diameter (in)												
		IPS (in)												
		1/2	3/4	1	1-1/4	1-1/2	2	2-1/2	3	4	5	8	10	12
		Tubing Size (in)												
		3/4	1	1-1/4	1-1/2	2								
1.0 (25)	+10 (-12)	0.3	0.4	0.4	0.5	0.6	0.7	0.8	0.9	1.1	1.5	1.9	2.4	2.7
	+50 (+10)	1.7	1.9	2.2	2.5	2.8	3.3	3.8	4.4	5.4	7.5	9.5	11.5	13.5
	+100 (+38)	3.5	3.9	4.5	5.3	5.8	6.8	7.9	9.2	11.3	15.7	19.8	24.5	28.2
	+150 (+66)	5.4	6.2	7.1	8.3	9.1	10.7	12.4	14.4	17.5	24.6	31.0	37.8	44.2
	+200 (+93)	7.5	8.6	9.9	11.5	12.6	14.9	17.2	20.0	24.5	34.2	43.2	52.6	61.5
	+250 (121)	9.8	11.2	12.8	15.0	16.5	19.4	22.4	26.0	31.9	44.6	56.1	68.4	80.0
1.5 (38)	+10 (-12)	0.3	0.3	0.4	0.4	0.4	0.5	0.6	0.7	0.8	1.1	1.4	1.6	1.9
	+50 (10)	1.3	1.5	1.7	1.9	2.1	2.5	2.8	3.2	3.9	5.3	6.7	8.1	9.4
	+100 (+38)	2.8	3.1	3.5	4.1	4.4	5.1	5.9	6.8	8.2	11.2	14.0	16.9	19.7
	+150 (+66)	4.4	4.9	5.5	6.4	6.9	8.1	9.2	10.6	12.8	17.6	21.9	26.5	30.8
	+200 (+93)	6.1	6.8	7.7	8.9	9.7	11.2	12.8	14.7	17.8	24.4	30.5	36.9	42.9
	+250 (121)	7.9	8.9	10.0	11.6	12.6	14.6	16.7	19.2	23.2	31.8	39.6	48.0	55.8
2.0 (50)	+10 (-12)	0.2	0.3	0.3	0.4	0.4	0.4	0.65	0.5	0.6	0.9	1.1	1.3	1.5
	+50 (+10)	1.2	1.3	1.4	1.6	1.7	2.0	2.3	2.6	3.1	4.2	5.2	6.3	7.3
	+100 (+38)	2.4	2.7	3.0	3.4	3.7	4.3	4.8	5.5	6.6	8.9	11.0	13.2	15.3
	+150 (+66)	5.4	6.2	7.1	8.3	9.1	10.7	12.4	14.4	17.5	24.6	31.0	37.8	44.2
	+200 (+93)	5.3	5.9	6.6	7.5	8.1	9.3	10.5	12.0	14.4	19.4	24.0	28.8	33.4
	+250 (+121)	6.9	7.7	8.6	9.8	10.7	12.1	13.7	15.6	18.7	25.3	31.2	37.5	43.5
2.5 (63)	+10 (-12)	0.2	0.2	0.3	0.3	0.3	0.4	0.4	0.5	0.5	0.7	0.9	1.1	1.2
	+50 (+10)	1.0	1.2	1.3	1.4	1.6	1.8	2.0	2.3	2.7	3.6	4.4	5.2	6.0
	+100 (+38)	2.2	2.4	2.7	3.0	3.3	3.7	4.2	4.7	5.6	7.5	9.2	11.0	12.7
	+150 (+66)	3.4	3.8	4.2	4.8	5.1	5.8	6.6	7.4	8.8	11.7	14.4	17.2	19.9
	+200 (+93)	4.8	5.3	5.9	6.6	7.1	9.1	9.1	10.3	12.3	16.3	20.0	24.0	27.6
	+250 (+121)	6.2	6.9	7.6	8.6	9.3	10.6	11.9	13.5	16.0	21.3	26.1	31.2	36.0
3.0 (75)	+10 (-12)	0.2	0.2	0.3	0.3	0.3	0.3	0.4	0.4	0.5	0.6	0.8	0.9	1.1
	+50 (+10)	1.0	1.1	1.2	1.3	1.4	1.6	1.8	2.0	2.4	3.1	3.8	4.5	5.2
	+100 (+38)	2.0	2.2	2.5	2.8	3.0	3.4	3.7	4.2	5.0	6.5	8.0	9.5	10.9
	+150 (+66)	3.2	3.5	3.9	4.3	4.6	5.3	5.9	6.6	7.8	10.3	12.5	14.9	17.1
	+200 (+93)	4.4	4.9	5.4	6.0	6.5	6.7	8.2	9.2	10.8	14.3	17.4	20.7	23.8
	+250 (+121)	5.8	6.3	7.0	7.8	8.4	9.5	10.6	12.0	14.1	18.6	22.6	26.9	30.9

Note: Please contact your local EasyHeat sales representative for larger sizes.

EasyHeat™ TSR Cable

Pipe Freeze Protection and Pipe Temperature Maintenance, Self-Regulating, Cut-to-Length. For Commercial Applications.

Table 2: Insulation Factors

Insulation Type	Correction Factor
Glass Fiber	1.00
Calcium Silicate	1.72
Cellular Glass	1.84
Rigid Urethane	0.76
Foamed Elastomer	1.16
Mineral Fiber	1.20
Expanded Perlite	1.42
Mineral Wool	1.04
Polystyrene	1.04
Flexible Elastomer	1.16
Polyisocyanurate	0.68

Table 3: Heat Loss Adder

Pipe Size in (mm)	Flange	Pipe Support	Valve
0.50 (12.7)	0.5	1.0	1.0
0.75 (19.1)	0.5	1.5	1.5
1.00 (25.4)	0.5	1.5	2.0
1.50 (38.1)	0.5	1.5	2.5
2.00 (50.8)	0.5	2.0	2.5
3.00 (76.2)	0.75	2.0	3.0
4.00 (101.6)	0.75	2.5	4.0
6.00 (152.4)	1.0	2.5	5.0
8.00 (203.2)	1.0	2.5	7.0

PIPE TRACING

Performance and Rating Data

Catalog Number	Service Voltage	Power Rating Watts/ft (Watts/m) @ +50 °F (+10 °C)	Maximum Single Run Length ft (m)	Over Jacket Material
TSR31J	120	3 (10)	325 (99)	Polyolefin
TSR31-F				Fluoropolymer
TSR32J	240	3 (10)	650 (198) ①	Polyolefin
TSR32-F				Fluoropolymer
TSR51J	120	5 (16)	270 (82)	Polyolefin
TSR51-F				Fluoropolymer
TSR52J	240	5 (16)	540 (165) ①	Polyolefin
TSR52-F				Fluoropolymer
TSR81J	120	8 (26)	210 (64)	Polyolefin
TSR81-F				Fluoropolymer
TSR82J	240	8 (26)	420 (128) ①	Polyolefin
TSR82-F				Fluoropolymer
TSR101J	120	10 (33)	180 (55)	Polyolefin
TSR101-F				Fluoropolymer
TSR102J	240	10 (33)	360 (110) ①	Polyolefin
TSR102-F				Fluoropolymer

① Lengths good for 208 and 277 Vac.

Voltage Adjustment Table

Cable	Power Rating Multiplier	
	208 Vac	277 Vac
TSR32J	0.85	1.13
TSR52J	0.87	1.09
TSR82J	0.88	1.08
TSR102J	0.89	1.05

Note:

- 1) Maximum maintenance temperature of all cables is +150 °F (+66 °C) with +185 °F (+85 °C) maximum intermittent exposure temperatures.
- 2) For applications in hazardous (classified) locations, all cables have a T5 surface temperature identification number.

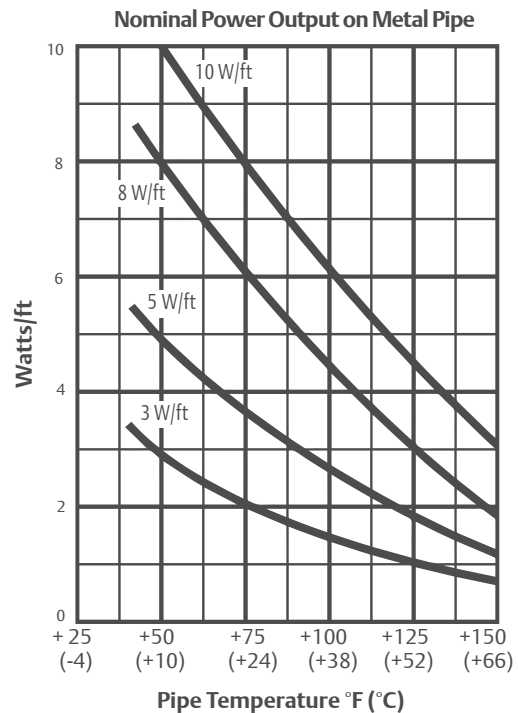

EasyHeat™ TSR Cable

Pipe Freeze Protection and Pipe Temperature Maintenance, Self-Regulating, Cut-to-Length. For Commercial Applications.

Circuit Breaker Selection

Voltage	Cable Power Watts/ft (Watts/m)	Start-up Temperature °F (°C)	Max. Total Cable Length vs. Circuit Breaker Rating			
			15A	20A	30A	40A
120	3 (10)	-20 (-29)	205 (63)	275 (84)	415 (127)	555 (169)
		0 (-18)	230 (70)	305 (93)	440 (134)	615 (188)
		+50 (+10)	325 (99)	435 (133)	655 (200)	875 (267)
	5 (16)	-20 (-29)	135 (41)	180 (55)	270 (82)	360 (110)
		0 (-18)	155 (47)	205 (72)	310 (94)	410 (144)
		+50 (+10)	225 (69)	270 (82)	450 (138)	540 (164)
	8 (26)	-20 (-29)	90 (27)	115 (35)	175 (53)	230 (70)
		0 (-18)	100 (30)	130 (40)	195 (59)	260 (80)
		+50 (+10)	145 (44)	195 (59)	290 (88)	390 (118)
	10 (33)	-20 (-29)	75 (23)	100 (30)	145 (44)	200 (60)
		0 (-18)	85 (26)	110 (34)	155 (47)	220 (68)
		+50 (+10)	115 (35)	150 (46)	230 (70)	300 (92)
240	3 (10)	-20 (-29)	410 (125)	545 (166)	820 (250)	1095 (334)
		0 (-18)	460 (140)	615 (188)	925 (282)	1235 (377)
		+50 (+10)	650 (198)	865 (264)	1300 (396)	1725 (529)
	5 (16)	-20 (-29)	844 (275)	379 (113)	540 (165)	758 (226)
		0 (-18)	310 (94)	415 (127)	620 (189)	830 (254)
		+50 (+10)	460 (140)	540 (165)	920 (280)	1080 (330)
	8 (26)	-20 (-29)	175 (53)	235 (72)	350 (107)	420 (128)
		0 (-18)	200 (61)	265 (81)	395 (120)	420 (128)
		+50 (+10)	295 (90)	390 (119)	590 (180)	780 (238)
	10 (33)	-20 (-29)	150 (46)	195 (59)	290 (83)	390 (118)
		0 (-18)	165 (50)	220 (67)	325 (99)	440 (134)
		+50 (+10)	230 (70)	305 (93)	460 (140)	610 (186)

Note: Please contact your local EasyHeat™ sales representative for larger sizes.

Example

- Straight water line (105 ft) to be maintained at +50 °F.
- Minimum ambient temperature is -10 °F.
- Pipe is 3 inches diameter steel.
- Insulation is 1 inch thick mineral fiber.
- Three valves

1. Calculate Temperature Differential

$$\Delta T = T_F - T_A$$

$$\Delta T = 50 - (-10) \text{ °F}$$

$$\Delta T = 60 \text{ °F}$$

2. Heat Loss

Use Table 1 to find the heat loss in W/ft. Where the desired temperature differential falls between two values, use interpolation:

$$\text{From Table 1: @ } 50 \text{ °F, } Q = 4.4 \text{ W/ft}$$

$$\text{@ } 100 \text{ °F } Q = 9.2 \text{ W/ft}$$

Therefore:

$$QF = 4.4 \text{ W/ft} + 10/50 \times (9.2 - 4.4 \text{ W/ft})$$

$$QF = 4.4 + .96 = 5.4 \text{ W/ft}$$

3. Adjustment to Heat Loss

Adjust the heat loss for mineral fiber. From Table 2, the adjustment factor is 1.2. Since the piping is outdoors, no adjustment is necessary for the absence of wind.

$$QM = QF \times 1.2$$

$$QM = 5.4 \text{ W/ft} \times 1.2$$

$$QM = 6.5 \text{ W/ft}$$

4. Determine Cable Power

Select 8 W/ft cable. Apply single cable straight along the pipe.

5. Adjustment For Heat Sinks

From Table 3, an additional 3 feet of cable is required at each valve.

6. Determine Cable Length

$$\text{Length} = 105 \times 1 + 3 \times 3 + \text{Slack}$$

$$\text{Slack} = 2 + 0 \times 2 + 1 \times 2 = 4$$

$$\text{Total Length} = 114 + 4 = 118 \text{ ft}$$

7. Select Accessories

- Use line sensing control T4XC with adjustable setting set to +50 °F.
- Power connection kit adjustable setting set to +50 °F.
- Power connection kit

EasyHeat™ TSR Cable

Pipe Freeze Protection and Pipe Temperature Maintenance, Self-Regulating, Cut-to-Length.
For Commercial Applications.

Product Selection

Catalog Number	Description	Carton Quantity	Carton Weight lb (kg)	UPC
TSR31J	3 Watts per foot (0.30 m), 120 Vac, polyolefin jacket, cut-to-order	1	0.102 (0.046) per foot	01362700299
TSR32J	3 Watts per foot (0.30 m), 240 Vac, polyolefin jacket, cut-to-order	1	0.102 (0.046) per foot	01362700300
TSR51J	5 Watts per foot (0.30 m), 120 Vac, polyolefin jacket, cut-to-order	1	0.102 (0.046) per foot	01362700293
TSR52J	5 Watts per foot (0.30 m), 240 Vac, polyolefin jacket, cut-to-order	1	0.102 (0.046) per foot	01362700212
TSR81J	8 Watts per foot (0.30 m), 120 Vac, polyolefin jacket, cut-to-order	1	0.152 (0.069) per foot	01362700301
TSR82J	8 Watts per foot (0.30 m), 240 Vac, polyolefin jacket, cut-to-order	1	0.152 (0.069) per foot	01362700258
TSR101J	10 Watts per foot (0.30 m), 120 Vac, polyolefin jacket, cut-to-order	1	0.152 (0.069) per foot	01362700241
TSR102J	10 Watts per foot (0.30 m), 240 Vac, polyolefin jacket, cut-to-order	1	0.152 (0.069) per foot	01362700923
TSR31F	3 Watts per foot (0.30 m), 120 Vac, fluoropolymer jacket, cut-to-order	1	0.112 (0.051) per foot	01362700302
TSR32F	3 Watts per foot (0.30 m), 240 Vac, fluoropolymer jacket, cut-to-order	1	0.112 (0.051) per foot	01362700303
TSR51F	5 Watts per foot (0.30 m), 120 Vac, fluoropolymer jacket, cut-to-order	1	0.112 (0.051) per foot	01362700304
TSR52F	5 Watts per foot (0.30 m), 240 Vac, fluoropolymer jacket, cut-to-order	1	0.112 (0.051) per foot	01362700305
TSR81F	8 Watts per foot (0.30 m), 120 Vac, fluoropolymer jacket, cut-to-order	1	0.135 (0.061) per foot	01362700306
TSR82F	8 Watts per foot (0.30 m), 240 Vac, fluoropolymer jacket, cut-to-order	1	0.135 (0.061) per foot	01362700307
TSR101F	10 Watts per foot (0.30 m), 120 Vac, fluoropolymer jacket, cut-to-order	1	0.135 (0.061) per foot	01362700308
TSR102F	10 Watts per foot (0.30 m), 240 Vac, fluoropolymer jacket, cut-to-order	1	0.135 (0.061) per foot	01362700309

PIPE TRACING

EasyHeat™ TSR Cable Connection Kits and Accessories

Pipe Freeze Protection and Pipe Temperature Maintenance. For Commercial Applications.

Product Overview

- All TSR self-regulating heating cables must be installed with appropriate connection kits.
- Kits contain all necessary components to terminate/connect TSR cable and any associated power supply.

TSRP Power Connection Kit

- Connects up to two heating cables to customer supplied power wiring.
- Seals for up to 2 cable ends are provided.
- Models: TSRP3, TSRP12, TSRP20.
- One year limited warranty.

TSRS Splice Connection Kit

- Connects two heating cables together in an in-line splice configuration.
- Models: TSRS3, TSRS12, TSRS20.
- One year limited warranty.

TSRT Tee Connection Kit

- Connects heating cables in a tee splice configuration.
- Seals for up to 2 cable ends are provided.
- Models: TSRT3, TSRT12, TSRT20.
- One year limited warranty.

TSRL Pilot Light Kits

- End-of-circuit indicating light assembly utilizes low temperature LED lamps.
- Kits available for 120 Vac, 208 Vac, 240 Vac and 277 Vac operation.
- Models: TSRL112, TSRL812, TSRL212, TSRL712.
- One year limited warranty.

SRME End Seal Kit

- Used for terminating the ends of field-fabricated heating cables.
- Constructed of molded silicone material with waterproof silicone adhesive.
- Kit contains materials to make 5 complete terminations.
- One year limited warranty.

SRMP Power End Connection Kit

- Used for terminating field-fabricated heating cables inside the power connection box.
- Constructed of molded silicone material with waterproof silicone adhesive.
- Kit contains materials to make 5 complete connections.
- One year limited warranty.

Certifications

- UL Listed, CSA Certified and Factory Mutual Approved for use in Class I, Division 2 locations.

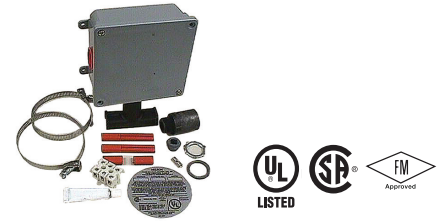

TSRP Power Connection Kit



TSRS Splice Connection Kit

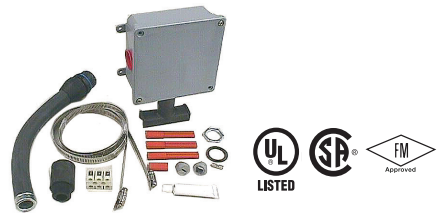

TSRT Tee Connection Kit



TSRL Pilot Light Kits



SRME End Seal Kit



SRMP Power End Connection Kit

EasyHeat™ TSR Cable Connection Kits and Accessories

Pipe Freeze Protection and Pipe Temperature Maintenance. For Commercial Applications.

Product Selection

Catalog Number	Description	Carton Quantity	Carton Weight lb (kg)	UPC
TSRP3	Power/end connection kit: up to 3 in (7.62 cm) pipe	1	2 (0.9)	01362707050
TSRP12	Power/end connection kit: up to 12 in (30.48 cm) pipe	1	2 (0.9)	01362707051
TSRP20	Power/end connection kit: up to 20 in (50.80 cm) pipe	1	2 (0.9)	01362707052
TSRS3	In-line splice kit: up to 3 in (7.62 cm) pipe	1	2 (0.9)	01362707053
TSRS12	In-line splice kit: up to 12 in (30.48 cm) pipe	1	2 (0.9)	01362707054
TSRS20	In-line splice kit: up to 20 in (50.80 cm) pipe	1	2 (0.9)	01362707055
TSRT3	T-splice kit: up to 3 in (7.62 cm) pipe	1	2 (0.9)	01362707056
TSRT12	T-splice kit: up to 12 in (30.48 cm) pipe	1	2 (0.9)	01362707057
TSRT20	T-splice kit: up to 20 in (50.80 cm) pipe	1	2 (0.9)	01362707058
TSRL112	End-of-circuit light kit: 120 Vac, 12 in (30.48 cm) pipe and below	1	2 (0.9)	01362707059
TSRL812	End-of-circuit light kit: 208 Vac, 12 in (30.48 cm) pipe and below	1	2 (0.9)	01362707060
TSRL212	End-of-circuit light kit: 240 Vac, 12 in (30.48 cm) pipe and below	1	2 (0.9)	01362707061
TSRL712	End-of-circuit light kit: 277 Vac, 12 in (30.48 cm) pipe and below	1	2 (0.9)	01362707062
SRME	End Seal Termination Kit	1	0.4 (0.2)	01362700227
SRMP	Power End Termination Kit	1	0.4 (0.2)	01362700226

PIPE TRACING

EasyHeat™ Domestic Hot Water Temperature Maintenance System

Pipe Temperature Maintenance, Self-Regulating, Cut-to-Length. For Commercial Applications.

Product Overview

- EasyHeat domestic hot water heating cable is an energy-efficient and economical alternative to common recirculation systems.
- The heating cable is used to maintain water temperature in the supply piping system, reducing or eliminating the delay in obtaining hot water at each fixture.

Applications

- This cable system eliminates the need for return piping, pumps, check valves and pressure balancing valves found in recirculating systems.
- In addition, maintenance requirements are greatly reduced through the elimination of all devices with moving parts connected to the recirculating portion of the hot water supply system.
- The standard product offering has been designed to maintain nominal domestic water temperatures of +105 °F, +115 °F, +125 °F and +140 °F (+41 °C, +46 °C, +52 °C and +60 °C).
- These representative hot water temperatures are in accordance with the ASHRAE Applications Handbook, Service Water Heating.
- The heating cables are UL Listed for domestic hot water temperature maintenance and meet all requirements of IEEE Standard 515.1, Recommended Practice for the Testing, Design, Installation, and Maintenance of Electrical Resistance Heat Tracing for Commercial Applications.

Features

- EasyHeat self-regulating heater cable is a parallel circuit electric heater strip.
- An irradiation cross-linked conductive polymer core material is extruded over the multi-stranded, tin-plated, 16-gauge copper bus wires.
- The conductive core material increases or decreases its heat output in response to temperature changes.
- Two jackets provide extra dielectric strength, moisture resistance, and protection from impact and abrasion damage. The inner thermoplastic jacket is extruded over and bonded to the core material.
- A thermoplastic elastomer over jacket is then extruded over the inner jacket.
- A stranded tinned copper metal braid is supplied on all heaters. A color-coded modified polyolefin over jacket is supplied for positive identification during installation.

Operating Principle

- The parallel bus wires apply voltage along the entire length of the heater cable.
- The conductive core provides an infinite number of parallel conductive paths permitting the cable to be cut to any length in the field with no dead or cold zones developing.
- The heater cable derives its self-regulating characteristic from the inherent properties of the conductive core material.

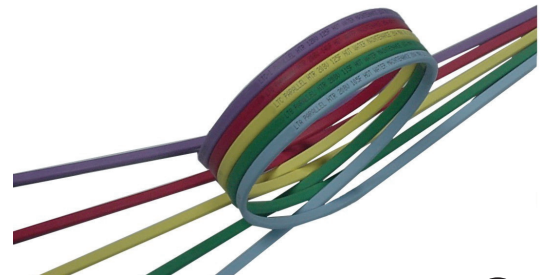

- As the core material temperature increases, the number of conductive paths in the core material decrease, automatically decreasing the heat output.
- As the temperature decreases, the number of conductive paths increase, causing the heat output to increase.
- This occurs at every point along the length of the cable, adjusting the power output to the varying conditions along the pipe.
- The self-regulating effect allows the cable to be overlapped without creating hot spots or burnout.
- As the cable self-regulates its heat output, it provides for the efficient use of electric power, producing heat only when and where it is needed.

Accessories

- TSR Series Connection Kits with Enclosures
- SR Series Heat Shrink Connection Kits
- SR Series Silicone Termination Kits
- C3RC Thermostat
- EGPC Digital Electronic Controller (Wall Mounted).

Certifications

- UL Listed, rated for use in Ordinary (Unclassified) Locations.

EasyHeat™ Domestic Hot Water Temperature Maintenance System

Pipe Temperature Maintenance, Self-Regulating, Cut-to-Length. For Commercial Applications.

Product Selection

Catalog Number	Color Code	Service Voltage	Maximum Segment Length m (ft)	Nominal Maintenance Temperature °C (°F)	Ambient Temperature Range °C (°F)
HW8105	Blue	208	246.9 (810.0)	+41 (+105)	+23 to +26 (74-79)
HW8115	Green	208	234.7 (770.0)	+46 (+115)	+21 to +26 (+70 to +78)
HW8125	Yellow	208	219.5 (720.0)	+52 (+125)	+21 to +26 (+70 to +78)
HW8140	Red	208	217.9 (715.0)	+60 (+140)	+21 to +26 (+70 to +78)
HW1125	Purple	120	100.6 (330.0)	+52 (+125)	+21 to +26 (+70 to +78)

Notes

1. The EasyHeat Domestic Hot Water Temperature Maintenance System has been designed to provide nominal pipe temperatures under specific conditions. Due to variations in sealing techniques, operating environment, installation methods, etc., exact temperatures cannot be assured without thermostatic control. This is recommended in applications where critical temperature tolerances are required.
2. If the specified installation does not comply with published application values, please consult your authorized factory representative. Product is designed for applications on copper supply piping with standard fiberglass insulation of the thickness noted in the Product Selection Tables. Contact your Nelson representative if using other types of insulation.

Circuit Breaker Selection

Cable Type	Start-Up Temp. °C (°F)	Service Voltage	Maximum Length in Meters (Feet) Vs. Circuit Breaker Size — 120 Vac			
			15 Amp	20 Amp	30 Amp	40 Amp
HW8105	+10 (+50)	208	247 (810)	329 (1080)	494 (1620)	658 (2160)
HW8115	+10 (+50)	208	157 (515)	209 (685)	314 (1030)	418 (1370)
HW8125	+10 (+50)	208	104 (340)	137 (450)	207 (680)	276 (905)
HW8140	+10 (+50)	208	87 (285)	116 (380)	174 (570)	232 (760)
HW1125	+10 (+50)	120	70 (230)	93 (305)	140 (460)	186 (610)

Notes

1. Maximum segment length is the maximum continuous heater run with minimal voltage drop. For breaker loading, multiple heater segments can be installed in parallel providing no individual length is longer than the maximum segment length.
2. Circuit breakers are sized per North American electrical codes.
3. When using 2 or more heater cables of different ratings in parallel on a single circuit breaker, use the 15 Amp column amperage of 15 Amps, divide it by the maximum footage to arrive at an Amps/foot figure for each cable. You can then calculate circuit breaker sizes for these combination loads. These Amps/foot factors include the sizing factors required by North American electrical codes.
4. North American electrical codes require ground-fault equipment protection for each branch circuit supplying electric pipe heating equipment.

EasyHeat™ Domestic Hot Water Temperature Maintenance System

Pipe Temperature Maintenance, Self-Regulating, Cut-to-Length. For Commercial Applications.

Insulation Thickness ① Millimeters (Inches)	Copper Pipe Diameter (IPS) in Inches											
	1/2	3/4	1	1-1/4	1-1/2	2	2-1/2	3	4	5	6	
+41 °C (+105 °F) Hot Water System HW8105 @ 208 Vac												
12 (0.5)	X	X	X	X	X							
25 (1.0)					X	X	X	X				
38 (1.5)							X	X	X	X		
50 (2.0)									X	X	X	
+46 °C (+115 °F) Hot Water System HW8115 @ 208 Vac												
12 (0.5)	X	X	X	X								
25 (1.0)				X	X	X	X					
38 (1.5)						X	X	X	X			
50 (2.0)							X	X	X	X	X	X
+52 °C (+125 °F) Hot Water System HW8125 @ 208 Vac												
12 (0.5)	X	X	X	X								
25 (1.0)				X	X	X	X					
38 (1.5)						X	X	X	X			
50 (2.0)							X	X	X	X	X	X
+60 °C (+140 °F) Hot Water System HW8140 @ 208 Vac												
12 (0.5)	X	X										
25 (1.0)		X	X	X	X							
38 (1.5)				X	X	X	X					
50 (2.0)						X	X	X	X	X	X	X
+52 °C (+125 °F) Hot Water System HW1125 @ 120 Vac												
12 (0.5)	X	X	X									
25 (1.0)			X	X	X	X						
38 (1.5)					X	X	X	X				
50 (2.0)							X	X	X	X	X	X

① Fiberglass Insulation

PIPE TRACING

EasyHeat™ HSR Cable

Pipe Freeze Protection and Pipe Temperature Maintenance, Self-Regulating, Cut-to-Length. For Commercial Applications.

Product Overview

- HSR self-regulating heating cables are used in high temperature commercial and industrial applications.
- The self-regulating heating cable automatically varies its heat output as the surrounding temperature changes.

Applications

- Pipe freeze protection or temperature maintenance applications, in either ordinary or hazardous locations.
- Maintains the temperature and viscosity of piped liquids in high temperature commercial applications, as may be required on large pipes which are periodically cleaned with high pressure steam.
- Suitable for refrigeration/HVAC condensation lines that are subject to freezing temperatures.

Features

- Maintains liquids in pipes at temperatures exceeding +150 °F (+66 °C) up to 420 °F (+215 °C) maximum intermittent exposure temperatures.
- Available for 120, 208, 240, and 277 Vac applications.
- Available in circuit lengths up to 785 ft (239.27 m) with output up to 20 Watts per foot (0.30 m) at +50 °F (+10 °C).
- Parallel resistance, cut-to-length cable is provided on bulk spools.
- Fluoropolymer over jacket for enhanced chemical resistance.
- Can be wrapped over itself (overlapped), if necessary, when installed on pipes, valves or flanges.
- One year limited warranty.

Accessories

- HSR cables use TSR accessories for power/end connections, splicing and end-of-circuit termination. See *EasyHeat TSR Accessories*.

Related Products

- It is recommended that heating cables for freeze protection and temperature maintenance be controlled by a thermostat to optimize energy consumption. See *EasyHeat Pipe Tracing Controls*.

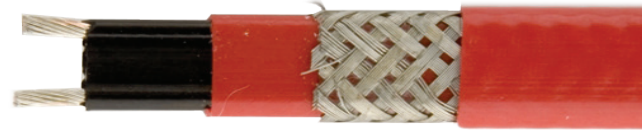

Control options are as follows:

- Ordinary areas
 - C4XC Thermostat
 - T4XC Thermostat
 - T4XA Thermostat
- Hazardous locations areas
 - T9EC Thermostat
 - T9EA Thermostat

Certifications

- CSA Certified, Factory Mutual Approved, and UL Listed for ordinary locations when used with EasyHeat accessories.
- UL Listed for use in Class I, Division 2 Hazardous locations with a T3 Temperature rating, when used with approved termination accessories.

Notes

- Per NEC and CEC requirements ALWAYS use a ground fault protection device (GFPE) to reduce the danger of fire from a damaged or improperly installed heating cable. Electrical fault currents caused by damaged or improperly installed cable MAY NOT BE LARGE ENOUGH to trip a conventional circuit breaker.
- Heating cables must be installed in compliance with all national, state/provincial and local codes. Check with your local electrical inspector for specific details.
- Do not twist the bus wires together at either end of the cable.
- Maximum maintenance temperature of all cables is +250 °F (+121 °C) with +375 °F (+191 °C) maximum intermittent exposure temperature.
- It is recommended that all heat traced pipes have a minimum of 1/2 inch (12.7 mm) of fiberglass insulation or equivalent.
- All electrical connections in the system must be sealed against moisture.
- Do not expose heating cables to temperatures above their maximum ratings.
- Immediately replace any damaged heating cable or components.
- Classified areas (explosive dust or gas) require the use of special electrical components.

PIPE TRACING

Illustrated Features

A special self-regulating core is at the center of the HSR cable. This core is conductive and adjusts according to the surrounding temperatures. When it is cold, the cable's core has many conductive paths that generate enough heat to keep the water flowing in the pipe. As the surrounding temperature warms, there are fewer conductive paths and less heat is generated.

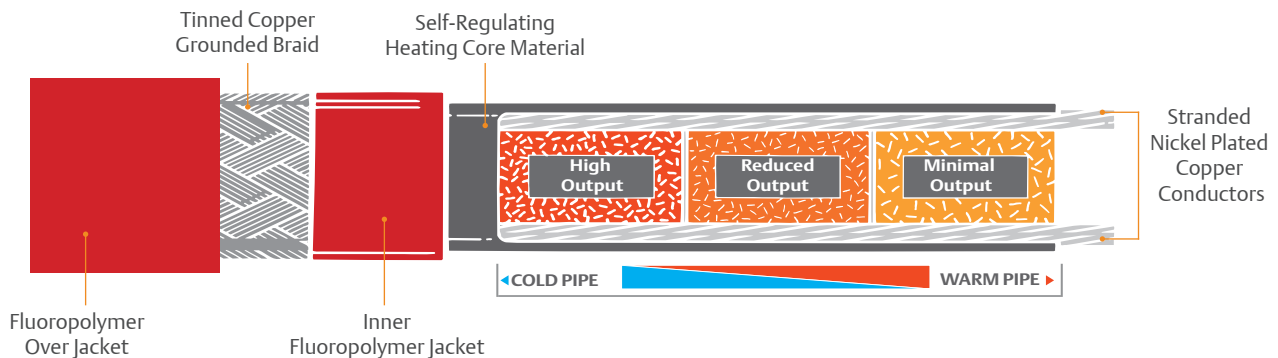

EasyHeat™ HSR Cable

Pipe Freeze Protection and Pipe Temperature Maintenance, Self-Regulating, Cut-to-Length. For Commercial Applications.

How To Determine The Length of Cable You Need

Design Procedure

The following procedure can be used to select a heating cable system for your application. To determine the heat loss that must be replaced by the heating cable, the following should be determined:

- T_F Fluid temperature to be maintained
- T_A Minimum ambient temperature
- Size and material of pipe to be heated
- Thermal insulation – type and thickness
- Pipe supports and valves, etc.

1. Temperature Differential

Determine the temperature differential (ΔT) to be maintained by subtracting the ambient temperature (T_A) from the fluid temperature (T_F) to be maintained ($\Delta T = T_F - T_A$). Typically, for pipe freeze protection applications, the pipe temperature should be maintained at +40 °F (+4 °C). Pipe temperatures should be maintained at +110 °F (+43 °C) for grease disposal lines and +40 °F (+4 °C) for fuel lines.

2. Heat Loss

Use Table 1. Pipe Heat Loss (W/ft), to look up the heat loss associated with the pipe diameter and thickness of insulation. If a rigid insulation such as calcium silicate is used, the pipe heat loss should be increased to that associated with the next larger size. Insulation should also be oversized when using any cable other than the standard self-regulating HSR, without over jacket.

As an example, you would use 2 in (50 mm) pipe diameter heat losses for 1-1/2 in (38 mm) pipe heating application if rigid insulation were used. Heat loss figures from Table 1, include a 10% safety factor.

3. Adjustments to Heat Loss Values

The heat loss values in Table 1 are based on glass fiber insulation. If other insulations are used, multiply the heat loss value by the correction factor for your insulation shown in Table 2: Insulation Factors.

Heat losses are based on outdoor applications with 20 mph wind. If piping is used indoors, multiply heat loss values by 0.9.

4. Determine Cable Power

For example, for heat loss of 30 W/ft, use two 15 W/ft cables. Cable power may exceed heat loss by up to 50%. It is also possible to spiral cable on pipe such that the power applied to the pipe exactly matches the pipe heat loss.

For example, for heat loss of 13 W/ft, a 10 W/ft cable can be spiraled on the pipe such that 1.3 ft (0.4 m) of cable are wound on every foot of pipe, resulting in exactly 13 W/ft being applied to the pipe.

However, spiraling requires significant extra labor to install and significant clearance around the pipe. For this reason, we do not recommend spiraling. For further information on spiraling, contact your local EasyHeat sales representative.

5. Adjustments For Heat Sinks

Any thermally conductive item that protrudes through the insulation will require extra heat to be applied to the pipe. The footage shown in Table 3 should be added to the required heating cable length to compensate for these extra heat losses. When multiple-tracing or spiraling cable, increase the cable adders proportionately.

6. Determine Cable Length

Cable length = (pipe length \times N) + (heat sink adjustments \times N) + (slack \times N)

Slack = (2 ft for power supply) + (2 ft per tee) + (2 ft per tail)

N = number of traces

EasyHeat™ HSR Cable

Pipe Freeze Protection and Pipe Temperature Maintenance, Self-Regulating, Cut-to-Length. For Commercial Applications.

Performance and Rating Table

Catalog Number	Power Rating Voltage	Maximum Watts/ft (Watts/m) @ 50 °F (10 °C)	Maximum Single Run Length ft (m)	Temperature Rating
HSR51F	120	5 (16)	310 (94)	T3
HSR52F	240	5 (16)	620 (189)	T3
HSR101F	120	10 (33)	190 (58)	T3
HSR102F	240	10 (33)	375 (114)	T3
HSR151F	120	15 (49)	135 (41)	T3
HSR152F	240	15 (49)	270 (82)	T3
HSR201F	120	20 (66)	105 (32)	T3
HSR202F	240	20 (66)	210 (64)	T3

Maximum maintenance temperature of all cables is +250°F (+121°C) with +375°F (+191°C) maximum intermittent exposure temperatures.

Circuit Breaker Selection

Watts/ft	Maximum Length vs Circuit Breaker Size ft (m)					
	120 Volt			240 Volt		
	15A	20A	30A	15A	20A	30A
5	185 (56)	245 (75)	370 (113)	385 (117)	500 (152)	770 (235)
10	115 (35)	150 (46)	230 (70)	225 (69)	300 (91)	450 (137)
15	80 (24)	110 (34)	160 (49)	160 (49)	215 (66)	320 (98)
20	65 (20)	85 (26)	130 (40)	125 (38)	170 (52)	250 (76)

Voltage Adjustment Table

Cable	Power Rating Multiplier		
	208 Vac	220 Vac	277 Vac
HSR52	0.76	0.85	1.29
HSR102	0.80	0.88	1.23
HSR152	0.83	0.89	1.19
HSR202	0.88	0.93	1.15

Power Output Rating

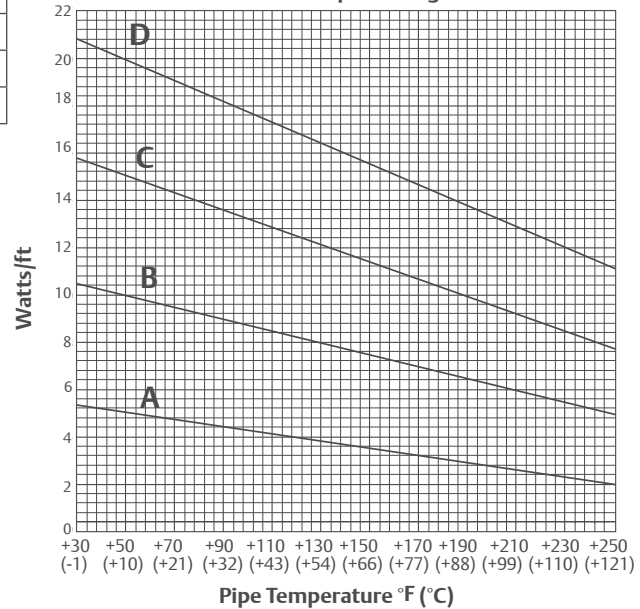

A HSR51F HSR52F B HSR101F HSR102F C HSR151F HSR152F D HSR201F HSR202F

PIPE TRACING

Example

- Straight water line (105 ft) to be maintained at +50 °F.
- Minimum ambient temperature is -10 °F.
- Pipe is three-inch diameter steel.
- Insulation is one inch thick mineral fiber.
- Three valves

1. Calculate Temperature Differential

$$\Delta T = T_F - T_A$$

$$\Delta T = 50 - (-10) \text{ °F}$$

$$\Delta T = 60 \text{ °F}$$

2. Heat Loss

Use Table 1 to find the heat loss in W/ft. Where the desired temperature differential falls between two values, use interpolation:

From Table 1: @ 50 °F, Q = 4.4 W/ft
@ 100 °F Q = 9.2 W/ft

Therefore:

$$QF = 4.4 \text{ W/ft} + 10/50 \times (9.2 - 4.4 \text{ W/ft})$$

$$QF = 4.4 + .96 = 5.4 \text{ W/ft}$$

3. Adjustment to Heat Loss

Adjust the heat loss for mineral fiber. From Table 2, the adjustment factor is 1.84. Since the piping is outdoors, no adjustment is necessary for the absence of wind.

$$QM = QF \times 1.84$$

$$QM = 5.4 \text{ W/ft} \times 1.84$$

$$QM = 9.93 \text{ W/ft}$$

4. Determine Cable Power

Select 10 W/ft cable. Apply single cable straight along the pipe.

5. Determine Cable Length

$$\text{Length} = 105 \times 1 + 3 \times 3 + \text{Slack}$$

$$\text{Slack} = 2 + 0 \times 2 + 1 \times 2 = 4$$

$$\text{Total Length} = 114 + 4 = 116 \text{ ft}$$

6. Adjustment For Heat Sinks

From Table 3, an additional 3 feet of cable is required at each valve.

EasyHeat™ HSR Cable

Pipe Freeze Protection and Pipe Temperature Maintenance, Self-Regulating, Cut-to-Length.
For Commercial Applications.

Table 1: Pipe Heat Loss, W/ft

Insulation Thickness in (mm)	ΔT °F (°C)	Pipe Diameter (in)												
		IPS (in)												
		1/2	3/4	1	1-1/4	1-1/2	2	2-1/2	3	4	5	8	10	12
Tubing Size (in)														
		3/4	1	1-1/4	1-1/2	2								
1.0 (25)	+10 (-12)	0.3	0.4	0.4	0.5	0.6	0.7	0.8	0.9	1.1	1.5	1.9	2.4	2.7
	+50 (+10)	1.7	1.9	2.2	2.5	2.8	3.3	3.8	4.4	5.4	7.5	9.5	11.5	13.5
	+100 (+38)	3.5	3.9	4.5	5.3	5.8	6.8	7.9	9.2	11.3	15.7	19.8	24.5	28.2
	+150 (+66)	5.4	6.2	7.1	8.3	9.1	10.7	12.4	14.4	17.5	24.6	31.0	37.8	44.2
	+200 (+93)	7.5	8.6	9.9	11.5	12.6	14.9	17.2	20.0	24.5	34.2	43.2	52.6	61.5
	+250 (+121)	9.8	11.2	12.8	15.0	16.5	19.4	22.4	26.0	31.9	44.6	56.1	68.4	80.0
1.5 (38)	+10 (-12)	0.3	0.3	0.4	0.4	0.4	0.5	0.6	0.7	0.8	1.1	1.4	1.6	1.9
	+50 (+10)	1.3	1.5	1.7	1.9	2.1	2.5	2.8	3.2	3.9	5.3	6.7	8.1	9.4
	+100 (+38)	2.8	3.1	3.5	4.1	4.4	5.1	5.9	6.8	8.2	11.2	14.0	16.9	19.7
	+150 (+66)	4.4	4.9	5.5	6.4	6.9	8.1	9.2	10.6	12.8	17.6	21.9	26.5	30.8
	+200 (+93)	6.1	6.8	7.7	8.9	9.7	11.2	12.8	14.7	17.8	24.4	30.5	36.9	42.9
	+250 (+121)	7.9	8.9	10.0	11.6	12.6	14.6	16.7	19.2	23.2	31.8	39.6	48.0	55.8
2.0 (50)	+10 (-12)	0.2	0.3	0.3	0.4	0.4	0.4	0.65	0.5	0.6	0.9	1.1	1.3	1.5
	+50 (+10)	1.2	1.3	1.4	1.6	1.7	2.0	2.3	2.6	3.1	4.2	5.2	6.3	7.3
	+100 (+38)	2.4	2.7	3.0	3.4	3.7	4.3	4.8	5.5	6.6	8.9	11.0	13.2	15.3
	+150 (+66)	3.8	4.2	4.7	5.4	5.8	6.7	7.6	8.6	10.3	13.9	17.2	20.7	24.0
	+200 (+93)	5.3	5.9	6.6	7.5	8.1	9.3	10.5	12.0	14.4	19.4	24.0	28.8	33.4
	+250 (+121)	6.9	7.7	8.6	9.8	10.7	12.1	13.7	15.6	18.7	25.3	31.2	37.5	43.5
2.5 (63)	+10 (-12)	0.2	0.2	0.3	0.3	0.3	0.4	0.4	0.5	0.5	0.7	0.9	1.1	1.2
	+50 (+10)	1.0	1.2	1.3	1.4	1.6	1.8	2.0	2.3	2.7	3.6	4.4	5.2	6.0
	+100 (+38)	2.2	2.4	2.7	3.0	3.3	3.7	4.2	4.7	5.6	7.5	9.2	11.0	12.7
	+150 (+66)	3.4	3.8	4.2	4.8	5.1	5.8	6.6	7.4	8.8	11.7	14.4	17.2	19.9
	+200 (+93)	4.8	5.3	5.9	6.6	7.1	9.1	9.1	10.3	12.3	16.3	20.0	24.0	27.6
	+250 (+121)	6.2	6.9	7.6	8.6	9.3	10.6	11.9	13.5	16.0	21.3	26.1	31.2	36.0
3.0 (75)	+10 (-12)	0.2	0.2	0.3	0.3	0.3	0.3	0.4	0.4	0.5	0.6	0.8	0.9	1.1
	+50 (+10)	1.0	1.1	1.2	1.3	1.4	1.6	1.8	2.0	2.4	3.1	3.8	4.5	5.2
	+100 (+38)	2.0	2.2	2.5	2.8	3.0	3.4	3.7	4.2	5.0	6.5	8.0	9.5	10.9
	+150 (+66)	3.2	3.5	3.9	4.3	4.6	5.3	5.9	6.6	7.8	10.3	12.5	14.9	17.1
	+200 (+93)	4.4	4.9	5.4	6.0	6.5	6.7	8.2	9.2	10.8	14.3	17.4	20.7	23.8
	+250 (+121)	5.8	6.3	7.0	7.8	8.4	9.5	10.6	12.0	14.1	18.6	22.6	26.9	30.9

Note: Please contact your local EasyHeat sales representative for larger sizes.

Table 2: Insulation Factors

Insulation Type	Correction Factor
Glass Fiber	1.00
Calcium Silicate	1.72
Cellular Glass	1.84
Rigid Urethane	0.76
Foamed Elastomer	1.16
Mineral Fiber	1.20
Expanded Perlite	1.42
Mineral Wool	1.04
Polystyrene	1.04
Flexible Elastomer	1.16
Polyisocyanurate	0.68

Table 3: Heat Loss Adder

Pipe Size in (mm)	Flange	Pipe Support	Valve
0.50 (12.7)	0.5	1.0	1.0
0.75 (19.1)	0.5	1.5	1.5
1.00 (25.4)	0.5	1.5	2.0
1.50 (38.1)	0.5	1.5	2.5
2.00 (50.8)	0.5	2.0	2.5
3.00 (76.2)	0.75	2.0	3.0
4.00 (101.6)	0.75	2.5	4.0
6.00 (152.4)	1.0	2.5	5.0
8.00 (203.2)	1.0	2.5	7.0

EasyHeat™ HSR Cable

Pipe Freeze Protection and Pipe Temperature Maintenance, Self-Regulating, Cut-to-Length.
For Commercial Applications.

Product Selection

Catalog Number	Description	Carton Quantity	Carton Weight lb (kg)	UPC
HSR51F	5 Watts per foot (0.30 m), 120 Vac, cut-to-order, fluoropolymer jacket	1	0.057 (0.026) per foot	01362700167
HSR52F	5 Watts per foot (0.30 m), 240 Vac, cut-to-order, fluoropolymer jacket	1	0.057 (0.026) per foot	01362700312
HSR101F	10 Watts per foot (0.30 m), 120 Vac, cut-to-order, fluoropolymer jacket	1	0.057 (0.026) per foot	01362700162
HSR102F	10 Watts per foot (0.30 m), 240 Vac, cut-to-order, fluoropolymer jacket	1	0.057 (0.026) per foot	01362700190
HSR151F	15 Watts per foot (0.30 m), 120 Vac, cut-to-order, fluoropolymer jacket	1	0.137 (0.062) per foot	01362700315
HSR152F	15 Watts per foot (0.30 m), 240 Vac, cut-to-order, fluoropolymer jacket	1	0.125 (0.057) per foot	01362700316
HSR201F	20 Watts per foot (0.30 m), 120 Vac, cut-to-order, fluoropolymer jacket	1	0.137 (0.062) per foot	01362700319
HSR202F	20 Watts per foot (0.30 m), 240 Vac, cut-to-order, fluoropolymer jacket	1	0.137 (0.062) per foot	01362700176

PIPE TRACING

EasyHeat™ MI Trace Cable

Pipe Temperature Maintenance, Constant Wattage, Hard-wired.
For Commercial Applications.

Product Overview

- MI Trace cable is a high performance, constant wattage, industrial grade heating cable. The Alloy 825 sheath is ideally suited for use in areas where higher temperatures and/or power outputs are required, a more rugged cable construction is needed, or required supply voltage exceeds 300 Vac. Applicable for metal pipes only.

Applications

- High temperature commercial where the liquids being piped during processing require constant temperatures.
- Suitable for refrigeration/HVAC condensation lines that are subject to freezing temperatures.

Features

- Available in custom engineered lengths for 120, 208, 240, 277, 347, 480, and 600 Vac applications.
- Two cable diameters available:
 - “K” cable diameter is 0.1875 in (3/16 in) [4.76 mm]
 - “B” cable diameter is 0.3125 in (5/16 in) [7.94 mm]
- Outer sheath construction is Alloy 825, a high temperature corrosion resistant alloy with superior flexibility.
- Available in single conductor (SMI) or dual conductor (DMI) construction.
- One year limited warranty.

Ordering Information

- We can assist you to select the appropriate heating cable for your application. Contact your local EasyHeat representative for details.

Related Products

- It is recommended that heating cables for freeze protection be controlled by a thermostat to minimize energy consumption. See *EasyHeat Pipe Tracing Controls*. Control options available:
 - C3RC Thermostat
 - C4XC Thermostat
 - T4XC Thermostat
 - T4XA Thermostat
 - T9EC Thermostat
 - T9EA Thermostat



- The following controls are available exclusively for Canada:
 - SMC51
 - SMC52
 - SMC54WP

Certifications

- UL Listed, CSA Certified, and Factory Mutual Approved for ordinary and hazardous locations.

Notes

- Per NEC and CEC requirements ALWAYS use a ground fault protection device (GFEP) to reduce the danger of fire from a damaged or improperly installed heating cable. Electrical fault currents caused by damaged or improperly installed cable MAY NOT BE LARGE ENOUGH to trip a conventional circuit breaker.
- Heating cables must be installed in compliance with all national, state/provincial and local codes. Check with your local electrical inspector for specific details.
- Install cable so minimal re-bending is required to service equipment. Cable will work harden and break if repeatedly re-bent.
- Do not bend the heating cable within 3 in (76.2 mm) of fittings. Fitting joints could be damaged.
- Do not bend the heating cable to an inside radius of less than five times the cable's diameter. This will damage the cable.
- Do not remove metal shipping splint.
- Do not remove stainless steel name plate and keep clearly visible after installation.

Illustrated Features

The MI Trace cable is a metal sheathed cable that uses metallic conductors as the heating elements. The conductors are electrically insulated from the metal sheath by mineral-magnesium oxide (MgO). The mineral insulated cable is a series resistance heater that generates heat when electrical current passes through the heating elements.

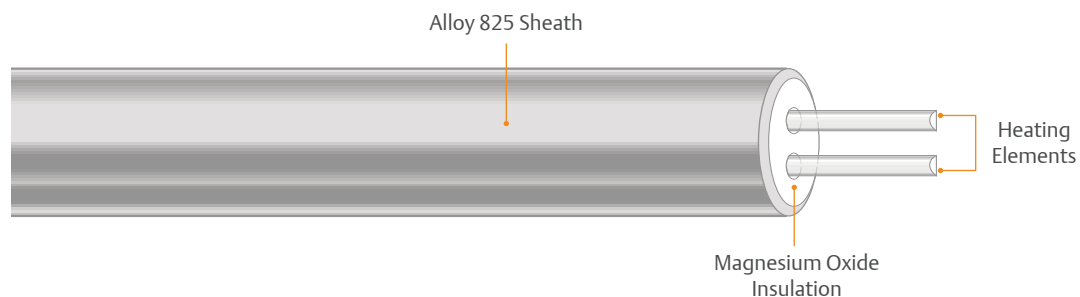

EasyHeat™ Crankcase Heaters

Pipe Freeze Protection, Self-Regulating, Pre-Terminated. For Commercial Applications.

Product Overview

- EasyHeat™ Crankcase Heater provides a simple yet highly effective solution for heating motors and compressors, prolonging unit life.

Applications

- Pre-heating of compressors and motors in ordinary and hazardous refrigeration/HVAC environments.

Features

- Designed for use as a heater on air conditioning and refrigeration metal compressors up to 42 in (1 m) in circumference.
- Warms up compressors during off hours and in cold environments.
- One product for numerous compressor brands and types.
- Simple cable-tie and power connections.
- Proven SR technology with factory sealed connections and water-resistant thermoplastic elastomer (TPE) jacket.
- One year limited warranty.

Certifications

- UL Recognized to both U.S. and Canadian safety requirements.



Notes

- Per NEC and CEC requirements ALWAYS use a ground fault protection device (GFEP) to reduce the danger of fire from a damaged or improperly installed heating cable. Electrical fault currents caused by damaged or improperly installed cable MAY NOT BE LARGE ENOUGH to trip a conventional circuit breaker.
- Heating cables must be installed in compliance with all national, state/provincial and local codes. Check with your local electrical inspector for specific details.
- Do not alter the length of the heating cable.
- Do not expose the cable to temperatures above +150 °F (+66 °C).
- Minimum installation temperature for the heating cable set is +32 °F (0 °C). Installation at lower temperatures will damage the cable and result in fire or shock hazard.
- There is no in-line thermostat or control built into the assembly. A thermostat can be used to control the cable to prevent the cable from operating when the compressor or ambient temperature is warm.
- It is recommended that the circuit supplying the heating cable have ground fault protection. Consult an electrical inspector to determine the specific ground fault requirements for your application prior to installation.
- Do not apply thermal insulation over the heating cable.

Power Outputs in Watts

	CH501	CH502			
Temperature	120 Vac	208 Vac	220 Vac	240 Vac	277 Vac
0 °F (-18 °C)	55 W	48 W	50 W	55 W	61 W
+30 °F (-1 °C)	46 W	40 W	43 W	46 W	52 W
+50 °F (+10 °C)	40 W	35 W	37 W	40 W	45 W
+100 °F (+38 °C)	25 W	22 W	23 W	25 W	28 W
Voltage Correction Factor	1.0	0.87	0.92	1.0	1.12

Product Selection

Catalog Number	Description	Carton Quantity	Carton Weight lb (kg)	UPC
CH501	Crankcase heater for 120 Vac	1	0.8 (0.4)	01362717586
CH502	Crankcase heater for 240 Vac	1	0.8 (0.4)	01362717587

EasyHeat™ Pipe Tracing Controls

Pipe Temperature Maintenance. For Commercial Applications.

Product Overview

- EasyHeat pipe tracing controls are intended for temperature control of a variety of electric heating cables and applications.

C3RC Thermostat

- Suitable for indoor/outdoor locations.
- Rainproof, gasketed enclosure can be used in ambient-sensing mode or line sensing mode.
- Voltage: 120, 208, 240 or 277 Vac
- Current: 22 Amps
- Enclosure: NEMA 3R rainproof gasketed cold-drawn steel with baked-on gray enamel
- Adjustable temperature range: 0 °F to +150 °F (-15 °C to +65 °C)
- Fixed differential temperature: +6 °F (+3.3 °C)
- Capillary length: 10 ft (3.0 m)
- Bulb exposure temperature: +190 °F (+88 °C)
- One year limited warranty.

C4XC Thermostat

- Suitable for indoor/outdoor locations having hostile, non-hazardous environments.
- Can be used in ambient sensing mode or line sensing mode.
- Voltage: 120, 208, 240 or 480 Vac
- Current: 22 Amps
- Enclosure: NEMA 4X molded gray fiberglass polyester
- Fixed temperature: +40 °F (+4.4 °C)
- Calibration accuracy: ±4 °F (±2.2 °C)
- Capillary length: 3 ft (0.9 m)
- Maximum exposure temperature: +140 °F (+60 °C)
- One year limited warranty.

T4XC Thermostat

- Suitable for indoor and outdoor locations in ordinary, non-hazardous (unclassified) environments.
- Can be used in an ambient sensing mode or a line sensing mode.
- Voltage: 125, 250, or 480 Vac
- Current: 22 Amps
- Enclosure: NEMA 4X polyurethane-coated die cast aluminum (maximum 0.6% copper)
- Adjustable temperature range: +25 °F to +325 °F (-3.9 °C to +162.8 °C)
- Calibration accuracy: ±3 °F (±1.7 °C)
- Capillary length: 10 ft (3 m)
- Bulb exposure temperature: +360 °F (+182 °C)
- Maximum enclosure temperature: +160 °F (+70 °C)
- One year limited warranty.

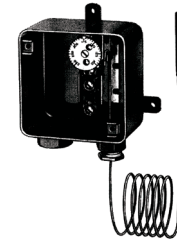

C3RC Thermostat



C4XC Thermostat



T4XC Thermostat



PIPE TRACING

EasyHeat™ Pipe Tracing Controls

Pipe Temperature Maintenance. For Commercial Applications.

T4XA Thermostat

- Suitable for indoor and outdoor locations in ordinary, non-hazardous (unclassified) environments.
- Ambient sensing thermostat.
- Voltage: 125, 250, or 480 Vac
- Current: 22 Amps
- Enclosure: NEMA 4X polyurethane-coated die cast aluminum (maximum 0.6% copper)
- Adjustable temperature range: +15 °F to +140 °F (-9 °C to +60 °C)
- Calibration accuracy: ±1.3 °F (±0.7 °C)
- Bulb exposure temperature: +160 °F (+71 °C)
- Maximum enclosure temperature: +160 °F (+70 °C)
- One year limited warranty.



T4XA Thermostat



T9EC Thermostat

- Suitable for indoor and outdoor locations in harsh industrial and hazardous (classified) environments.
- Line sensing thermostat.
- Voltage: 125, 250, or 480 Vac
- Current: 22 Amps
- Enclosure: NEMA 4, 7 and 9 lacquer-coated cast aluminum
- Adjustable temperature range: +25 °F to +325 °F (-3.9 °C to +162.8 °C)
- Calibration accuracy: ±3 °F (±1.7 °C)
- Capillary length: 10 ft (3 m)
- Bulb exposure temperature: +420 °F (+215 °C)
- One year limited warranty.



T9EC Thermostat



T9EA Thermostat

- Suitable for indoor and outdoor locations in harsh industrial and hazardous (classified) environments.
- Ambient sensing thermostat.
- Voltage: 125, 250, or 480 Vac
- Current: 22 Amps
- Enclosure: NEMA 4, 7 and 9 lacquer-coated cast aluminum
- Adjustable temperature range: +15 °F to +140 °F (-9 °C to +60 °C)
- Calibration accuracy: ±1.3 °F (±0.7 °C)
- Maximum bulb temperature: +160 °F (+71 °C)
- One year limited warranty.



T9EA Thermostat



Certifications

- UL Listed and CSA Certified.
- T9EC and T9EA thermostats are also Factory Mutual Approved.

Product Selection

Catalog Number	Description	Carton Quantity	Carton Weight lb (kg)	UPC
C3RC	SPDT, snap action thermostat, 22 Amp, 0 °F to +150 °F (-18 °C to +65 °C), 6° diff., 10 ft (3 m) capillary, NEMA 3R enclosure	1	2.7 (1.2)	01362701327
C4XC	SPST, snap action thermostat, 22 Amp, +40 °F (+4 °C) fixed, 3 ft (0.9m), capillary, NEMA 4X enclosure	1	2 (0.9)	01362701328
T4XC	SPDT, snap action thermostat, 22 Amp, +25 °F to +325 °F (-4 °C to +163 °C), 10 ft (3 m) capillary, NEMA 4X enclosure	1	4 (1.8)	01362701335
T4XA	NEMA 4X; 22 Amp; +15 °F to +140 °F (-9 °C to +60 °C), ambient thermostat	1	4 (1.8)	01362701332
T9EC	NEMA 4, 7, 9; 22 Amp; +25 °F to +325 °F (-4 °C to +163 °C), 10 ft (3m) capillary	1	5 (2.3)	01362701333
T9EA	NEMA 4, 7, 9; 22 Amp; +15 °F to +140 °F (-9 °C to +60 °C), ambient thermostat	1	5 (2.3)	01362701334

EasyHeat™ Pipe Tracing Controls

Pipe Temperature Maintenance. For Commercial Applications.

Available Exclusively for Canada.

Product Overview

- Our EasyHeat pipe tracing controls, available exclusively for Canada, are intended for temperature control of a variety of electric heating cables and applications.

SMC54WP Thermostat

- Available exclusively for Canada.
- One control for heating and cooling.
- Rugged, weather-resistant enclosure.
- Performs despite water spray, high humidity, airborne contaminants and moderately corrosive conditions.
- Large, visible dial to make set point temperatures clear.
- Reliable SPDT switch.
- Voltage: 120, 208, 240 or 277 Vac
- Current: 8 Amps
- Temperature range: -30 °F to +100 °F (-34 °C to +38 °C)
- One year limited warranty.



SMC54WP Thermostat



SMC51/SMC52 Thermostat

- Available exclusively for Canada.
- Universal mounting bracket is available for easy replacement.
- Control setpoint is dial-knob adjustable.
- Models are available with fixed or adjustable temperature differentials.
- Reliable SPDT switch.
- Ambient temperature compensated.
- Voltage: 120 or 240 Vac
- Current: 8 Amps
- Temperature range: -30 °F to +90 °F (-34 °C to +32 °C)
- One year limited warranty.



SMC51/SMC52 Thermostat



Certifications

- UL Listed and CSA Certified.

Product Selection

Catalog Number	Description	Carton Quantity	Carton Weight lb (kg)	UPC
SMC51	Indoor thermostat with 8 ft (2.40 m) capillary	1	2 (0.9)	01362700129
SMC52	Indoor thermostat with 20 ft (6.10 m) capillary	1	2 (0.9)	01362700214
SMC54WP	Weatherproof thermostat	1	2 (0.9)	01362716918

EasyHeat™ EGPC Digital Electronic Controller - Wall Mounted

General Purpose Controller. For Commercial Applications in Ordinary Locations.

Product Overview

- The EasyHeat EGPC micro-processor based digital controller provides temperature control of an individual heater segment with sensor monitoring, remote alarm contacts, and ground fault leakage detection.
- The controller system is housed in a NEMA 4X fiberglass reinforced, carbon impregnated, UV resistant polymer enclosure designed for wall mounted applications.
- The system is provided with dual pole heater switching and is environmental hardened for use in various plant locations.
- The EGPC can be installed in ordinary locations.
- The system is provided with a common alarm contact for remote monitoring of the control system.

Applications

- The EasyHeat EGPC has been specifically designed for wall mounted electric heat tracing applications.

Features

- Easy to use interface
 - The single line, alphanumeric LCD display enables the use of English language prompts for setpoint entry and operation. There are no cryptic codes or key press combinations to remember.
- Ground Fault Trip function
 - A fixed 30 mA trip level is provided for circuit integrity eliminating the need for separate EPD branch circuit breakers.
- Temperature Input:
 - Range: +32 °F to +425 °F (0 °C to +218 °C)
 - Accuracy: +/- 1 °C
 - Repeatability: +/- 1 °C
 - RTD: 100-ohm platinum, 3-wire, (sold separately) (lead compensated up to 20 ohms)
- Voltage Range: 100 Vac to 277 Vac
- Heater Switching
 - Configuration: Two-pole, EMR
 - Ratings: 100-277 Vac, 30 Amp continuous (resistive load only)
 - Line Frequency: 50 or 60 Hz
- Control Power
 - Power Requirement: Control power from heater voltage, 110-277 Vac, 12 VA max
- User Interface
 - Display: 4-character LCD Alphanumeric display
 - Panel Indicators:
 - Actual Temp LED
 - Setpoint Temp LED
 - Alarm LED
 - Keypad:
 - 4 buttons, glass-reinforced epoxy laminate faceplate
 - Next, Up, Down, Menu



- Environment
 - Ambient Temperature: -40 °F to +140 °F (-40 °C to +60 °C) Starting at -4 °F (-20 °C)
 - Conformal Coating: Boards conformal coated for hostile environments
- Enclosure
 - Type: NEMA Type 4X fiberglass reinforced, carbon impregnated, UV resistant polymer
 - Size: 6.5" H x 6.5" W x 4.0" D
 - Features: Captive cover screws
- Mounting
 - Configured for Wall Systems
- Alarm Output
 - Alarm: EMR Form C
 - Alarm Rating: EMR Version 24-277 Vac @ 2.0 Amp Max, 12-30 Vdc
 - Alarm Output: LED Indication
- Alarm Function
 - High Temperature Alarm
 - Low Temperature Alarm
 - Sensor Failure
 - Ground Fault Trip
- User-Definable Options
 - Deadband: Adjustable +2 °F to +10 °F (+1 °C to +6 °C)
 - Alarm Contacts: NO or NC operation.

Accessories

- EHRTD7 - RTD Temperature Sensor

Certifications

- UL Standard: UL60730-1/-2-9; UL1053
- CSA Standard: C22.2 No 24-15; C22.2 No. 144-M91
- cCSAus Certified: LR21208

EasyHeat™ AXPC100EGPC Combination Power Connection and Digital Electronic Controller - Pipe Mounted

General Purpose Controller. For Commercial Applications in Ordinary Locations.

Product Overview

- The EasyHeat AXPC100EGPC micro-processor based digital controller provides temperature control of an individual heater segment with sensor monitoring, remote alarm contacts, and ground fault leakage detection.
- The controller system is housed in a NEMA 4X fiberglass reinforced, carbon impregnated, UV resistant polymer enclosure designed for pipe mounted applications.
- The system is provided with dual pole heater switching and is environmental hardened for use in various plant locations.
- The AXPC100EGPC can be installed in ordinary locations.
- The system is provided with a common alarm contacts for remote monitoring of the control system.

Applications

- The EasyHeat AXPC100EGPC has been specifically designed for stand-alone pipe mounted electric heat tracing applications.

Features

- Easy to use interface
 - The single line, alphanumeric LCD display enables the use of English language prompts for setpoint entry and operation. There are no cryptic codes or key press combinations to remember.
- Ground Fault Trip function
 - A fixed 30 mA trip level is provided for circuit integrity eliminating the need for separate EPD branch circuit breakers.
- Temperature Input:
 - Range: +32 °F to +425 °F (0 °C to +218 °C)
 - Accuracy: +/- 1 °C
 - Repeatability: +/- 1 °C
 - RTD: 100-ohm platinum, 3-wire, (sold separately) (lead compensated up to 20 ohms)
- Voltage Range: 100 Vac to 277 Vac
- Heater Switching
 - Configuration: Two-pole, EMR
 - Ratings: 100-277 Vac, 30 Amp continuous (resistive load only)
 - Line Frequency: 50 or 60 Hz
- Control Power
 - Power Requirement: Control power from heater voltage, 110-277 Vac, 12 VA max
- User Interface
 - Display: 4-character LCD alphanumeric display
 - Panel Indicators:
 - Actual Temp LED
 - Setpoint Temp LED
 - Alarm LED
 - Keypad:
 - 4 buttons, glass-reinforced epoxy laminate faceplate
 - Next, Up, Down, Menu



- Environment
 - Ambient Temperature: -40 °F to +140 °F (-40 °C to +60 °C) Starting at -4 °F (-20 °C)
 - Conformal Coating: Boards conformal coated for hostile environments
- Enclosure
 - Type: NEMA Type 4X fiberglass reinforced, carbon impregnated, UV resistant polymer
 - Size: 6.5” H x 6.5” W x 4.0” D
 - Features: Captive cover screws
- Mounting
 - Configured for Piping Systems
 - AX Series Connection System
- Alarm Output
 - Alarm: EMR Form C
 - Alarm Rating: EMR Version 24-277 Vac @ 2.0 Amp Max, 12-30 Vdc
 - Alarm Output: LED Indication
- Alarm Function
 - High Temperature Alarm
 - Low Temperature Alarm
 - Sensor Failure
 - Ground Fault Trip
- User-Definable Options
 - Deadband: Adjustable +2 °F to +10 °F (+1 °C to +6 °C)
 - Alarm Contacts: NO or NC operation.

Accessories

- EHRTD7 - RTD Temperature Sensor

Certifications

- UL Standard: UL60730-1/-2-9; UL1053
- CSA Standard: C22.2 No 24-15; C22.2 No. 144-M91
- cCSAus Certified: LR21208

EasyHeat™ Pipe Tracing Accessories

Pipe Temperature Maintenance. For Residential and Commercial Applications.

Product Overview

- Pipe tracing accessories are used to attach heating cables and/or identify heat tracing applications.

NST2 Fiberglass Application Tape

- NST2 fiberglass application tape is heat resistant and used to attach heating cable to pipe for most applications.
- One year limited warranty.

ALT Aluminum Heat Transfer Tape

- ALT aluminum heat transfer tape is used on plastic pipes for even heat distribution.
- One year limited warranty.

CS Caution Labels

- CS caution labels are used to reduce the possibility of accidents and liability. These easy-to-read caution labels are packaged five per bag.
- One year limited warranty.

HCA Application Tape

- HCA application tape is 30 ft (9.14 m) of clear tape used to attach heating cable to pipe, rated for temperature so as not to lose its adhesive properties, and printed with the words *ELECTRICALLY HEATED PIPE* for easy identification.
- One year limited warranty.



NST2 Fiberglass Application Tape



ALT Aluminum Heat Transfer Tape

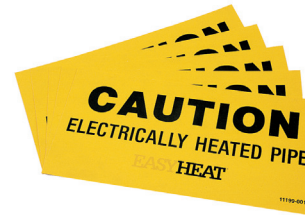

CS Caution Labels



HCA Application Tape

PIPE TRACING

Product Selection

Catalog Number	Description	Carton Quantity	Carton Weight lb (kg)	UPC
NST2	Fiberglass application tape, 0.75 in x 36 yd (0.02 m x 32.92 m)	1	1.5 (0.7)	01362709922
ALT1	Aluminum heat transfer tape, 2 in x 60 yd (0.05 m x 54.86 m)	1	2 (0.9)	01362706830
CS	Heated pipe caution labels, 5 per bag	1	0.25 (0.1)	01362709924
HCA	Application tape: 0.5 in x 30 ft (1.27 cm x 9.14 m)	10	2 (0.9)	01362706945



Roof and Gutter De-Icing

Emerson's roof and gutter de-icing products are engineered to protect properties from the damage caused by ice dam formations. Our EasyHeat™ brand of electric heating cables are designed to economically and efficiently reduce ice formation along roof edges, in gutters, drains and downspouts by providing a path for meltwater to flow off the roof. We offer the highest quality cables and controls for virtually every roof and gutter de-icing application.

EasyHeat™ Roof and Gutter De-Icing Product Selection Guide

Criteria	ADKS	PSR	SR Trace	RG
1. What is the area of application?				
Typical Application	Residential	Residential Commercial	Residential Commercial	Residential Commercial
Residential	✓	✓	✓	✓
Commercial/Warehouse/Building	–	✓	✓	✓
2. What is the roofing material?				
Noncombustible Shingles (ex. Asphalt Tab Shingles)	✓	✓	✓	✓
Rolled Asphalt	–	✓	✓	✓
Corrugated Metal	–	✓	✓	✓
Sun Roof (Glass/Plastic)	–	✓	✓	✓
EPDM/Rubber	–	✓	✓	✓
PVC	–	✓	✓	✓
Slate/Ceramic Roof	–	✓	✓	✓
Cedar Shingles/Wood Roof	–	✓	✓	✓
Tile Roof	–	✓	✓	✓
3. What is the power rating?				
Power Rating	Constant: 5 Watts/ft	Self-regulating: 5 Watts/ft @ +50 °F (+10 °C); 8 Watts/ft embedded in ice	Self-regulating: 5 Watts/ft @ +50 °F (+10 °C); 8 Watts/ft embedded in ice	Self-regulating: 12 Watts/ft embedded in ice
4. What is the available supply voltage?				
Supply Voltage (Vac)	120	120, 208, 240, 277	SR51J: 120 SR52J: 208, 240, 277	RG-1: 120 RG-2: 208, 240, 277
Power Cord	6 ft (1.83 m)	2.5 ft (0.76 m)	Not included	Not included
5. How much length of heating cable is needed?				
Cable Lengths	20 ft – 240 ft (6.1 m – 73.15 m)	6 ft – 100 ft (1.83 m – 30.48 m)	Cut-to-length (1 to 1,000 ft)	Cut-to-length (1 to 1,000 ft)

✓ Applicable
– Not Applicable

EasyHeat™ ADKS Cable

Roof and Gutter De-Icing, Constant Wattage, Pre-Terminated. For Residential Applications.

Product Overview

- ADKS roof and gutter de-icing cables prevent ice dam formation and promote the free flow of water through gutters and downspouts to ground level.

Applications

- Residential roof and gutter de-icing, for non-combustible asphalt shingle roofs.

Features

- 120 Vac operating voltage.
- Rated at 5 Watts per foot (0.30 m).
- Pre-terminated lengths from 20 ft to 240 ft (6 m to 73 m).
- Includes a three wire grounded plug with a 6 ft (2 m) power cord.
- Roof and gutter de-icing kits include the roof clips and cable spacers.
- Two year limited warranty.

Related Products

- Use of a temperature and moisture sensing control, such as the Roof Sentry RS2, is highly recommended. See *EasyHeat Roof and Gutter De-Icing Controls*.

Certifications

- UL Listed to Canadian Safety Standards and CSA Certified.

Notes

- Per NEC and CEC requirements ALWAYS use a ground fault protection device (GFEP) to reduce the danger of fire from a damaged or improperly installed heating cable. Electrical fault currents caused by damaged or improperly installed cable MAY NOT BE LARGE ENOUGH to trip a conventional circuit breaker.
- This product is for the sole intended use of preventing ice dams from forming on inclined roofs with tab shingles, in gutters and in downspouts.
- Never install on flat roofs, metal roofs, and other types of roofs except non-combustible asphalt tab shingles. Never install on combustible materials.
- This roof de-icing cable is not intended for use as a snow-melting system to clear roof of ice and snow.
- Do not use this cable to melt snow and ice that has already formed on your roof or in your gutters or downspouts.
- Do not modify the plug provided with the cable. If it will not fit the outlet, have a proper outlet installed by a licensed electrician.
- Do not use extension cords.



EasyHeat™ ADKS Cable

Roof and Gutter De-Icing, Constant Wattage, Pre-Terminated. For Residential Applications.

How To Determine The Length of Cable You Need

It is important to obtain an accurate estimate of the cable length you need because you cannot change the cable length in any way. Cable should be installed on roof areas where ice dams form. This can be the entire roof edge or specific areas such as beneath skylights, in valleys or around dormers. Cable should also be installed in any nearby gutters, downspouts and/or valleys.

- If you need to apply the cable on a roof with gutter, downspouts, valleys, and/or dormers, follow “For Typical Roof Applications”.
- If you need to install the cable in the gutters only, follow “For Problems in the Gutter Only”.
- If you need to install the cable on a roof with special roof areas such as a roof with skylights, follow “For Roofs with Special Roof Area Applications”.

For Typical Roof Application

Step 1. For each area listed in Table 1, measure the required dimensions (see Figures 1 and 2) and calculate the length of cable needed. Add each “area” calculation to determine the total cable length needed.

Step 2. Use the estimated cable length to select the proper de-icing cable from Table 3. Choose the longer cable if the length you need is between the sizes offered. If the difference is small, the shorter cable can be used. You cannot change the cable length by cutting, splicing or altering it in any way. If ice dams are occurring on roof areas that are a significant distance apart, you may want to use a separate cable for each location, instead of using one large cable. If roof areas are large, separate cables for the roof area and gutter should be used.

Table 1: Cable Length Estimation Formula for Typical Roof Applications

Area	What to Measure	How to Calculate
Along Roof	Overhang (A)	Length of roof (B) X overhang multiplier (see Table 2)
	Length along roof (B)	
Dormer	Distance around dormer (C)	Number of dormers X distance around dormer(s) (C)
Valley	Number of valleys (D)	Number of valleys (D) X 6 ft (1.8 m)
Downspouts	Number of downspouts	Number of downspouts X Length of downspout (E) X 2
	Length of downspouts (E)	

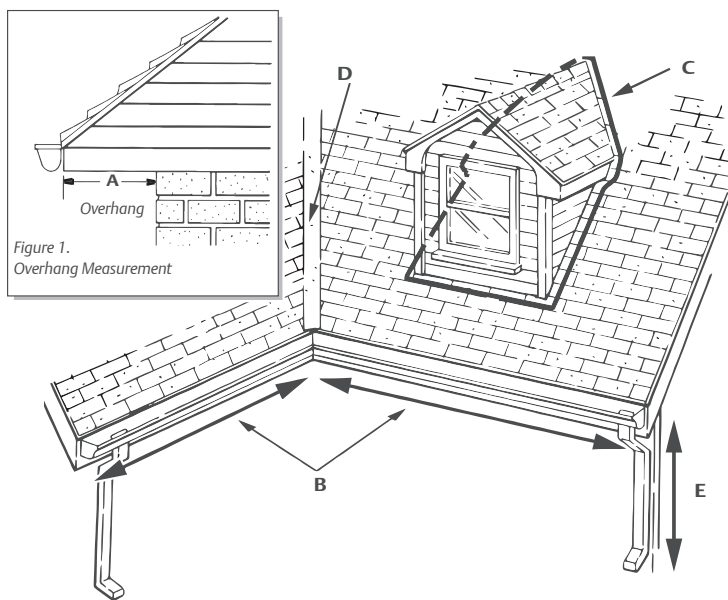

Figure 1. Overhang Measurement

Figure 2. Roof Measurements

Table 2: Overhang Multiplier

Roof Overhang in (cm)	Multiplier For roof with gutter	Multiplier For roof without gutter
Less than 12 (30)	4.0	3.0
12 (30)	4.0	3.0
24 (60)	5.3	4.3
36 (90)	6.8	5.8
48 (120)	8.1	7.1
60 (150)	9.6	8.6
72 (180)	11.2	10.2

Note: For overhangs not listed, estimate multiplier. For example, for an 18 in (45.7 cm) overhang with a gutter, multiplier will be about 4.7.

EasyHeat™ ADKS Cable

Roof and Gutter De-Icing, Constant Wattage, Pre-Terminated. For Residential Applications.

Table 3: De-Icing Kits

Catalog Number	Length ft (m)	Bags of Roof Clips Included
ADKS100	20 (6)	1
ADKS150	30 (9)	1
ADKS300	60 (18)	2
ADKS400	80 (24)	3
ADKS500	100 (31)	4
ADKS600	120 (37)	4
ADKS800	160 (49)	5
ADKS1000	200 (61)	7
ADKS1200	240 (73)	8

For Problems in the Gutter Only

If ice dams are occurring in gutters only, measure the required dimensions (see Figure 2) and calculate the length of cable needed for each area listed in Table 4. Add each “area” calculation to determine the total cable length needed.

Table 4: Cable Needed for Gutter Only Ice Problems

Area	How to Calculate
Gutter	Length of gutter (B) X 2
Downspouts	Number of downspouts X Length of downspout (E) X 2

For Roofs with Special Roof Area Applications

Step 1. For each area listed in Table 5, measure the required dimensions (see Figure 1 on and Figure 3) and calculate the length of cable needed. Add each “area” calculation to determine the total cable length needed.

Step 2. Use the estimated cable length calculated above to select the proper de-icing cable from Table 3. Choose the longer cable if the length you need is between the sizes offered. If the difference is small, the shorter cable can be used. You cannot change the cable length by cutting, splicing or altering it in any way. If ice dams are occurring on roof areas that area significant distance apart, you may want to use a separate cable for each location, rather than choosing one large cable. If roof areas are large, separate cables for the roof area and gutter should be used.

Table 5: Cable Length Estimation Formula for a Roof with Special Roof Areas

Area	What to Measure	How to Calculate
Along Roof	Overhang (A)	Length of roof (B) X overhang multiplier (see Table 2)
	Length along roof (B) ①	
Dormer	Distance around dormer (C)	Number of dormers X distance around dormer(s) (C)
Valley	Number of valleys (D)	Number of valleys (D) X 6 ft (1.8 m)
Downspouts	Number of downspouts	Number of downspouts X length of downspout (E) X 2
	Length of downspouts from roof to ground (E)	
Special roof areas (such as skylights)	Distance from roof edge to bottom of special roof area (F)	Distance from roof edge to bottom of special roof area (F) X width of ice dams that form along special roof area (G) X special roof area multiplier (see Table 6)
	Width of ice dams that form along special roof area (G)	

① Note: Do not include the width of special areas (G) in this measurement.

EasyHeat™ ADKS Cable

Roof and Gutter De-Icing, Constant Wattage, Pre-Terminated. For Residential Applications.

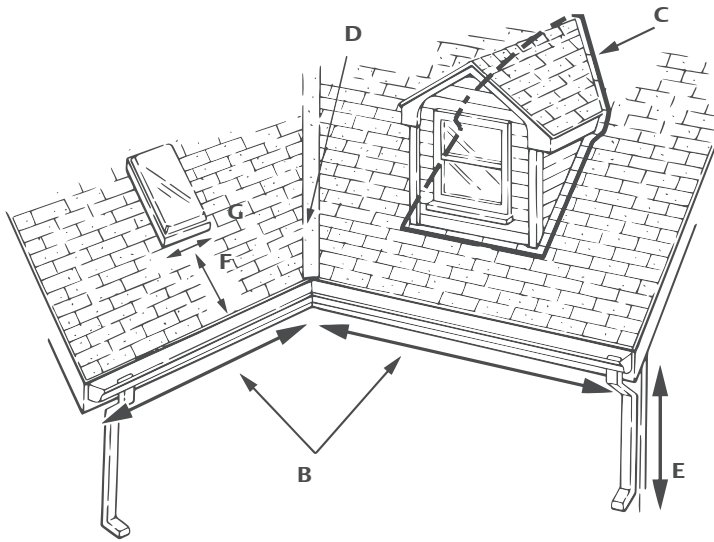

Table 6: Special Roof Area Multiplier

Multiplier for roof with gutter	Multiplier for roof without gutter
2.6	1.6

Figure B-3. Roof Measurements

Example 1: Example of Typical Estimation

If the roof section (See Figure 2) that you want to treat that has:

- 32 feet of roof
- An overhang of 12 inches with a gutter
- 1 dormer (30 feet around)
- 1 valley
- 2 downspouts (each 10 feet long)

From Table 2, the multiplier for a roof with a gutter and an overhang of 12 inches is 4.

Using Table 1, the cable length needed = $(32 \times 4) + (1 \times 30) + (1 \times 6) + (2 \times 10 \times 2) = 204$

Using Table 3, you would select the ADKS-1000 (200 feet of cable). You would select the smaller cable because the difference between the cable length and your calculation is less than 5 feet.

Example 2: Example of Special Roof Area Estimation

This example shows how to estimate the cable length needed for a limited problem roof area – a skylight (see Figure 3). For this roof, you would like to treat only the problem area underneath the skylight.

This roof section has:

- 1 downspout (10 feet long)
- 1 skylight (the distance from the bottom of the skylight to the roof edge is 12.5 feet, and the width of the ice dams that form beneath the skylight is about 6 feet)
- 1 gutter

From Table 6: Special Roof Area Multiplier, the special roof area multiplier for a roof with a gutter is 2.6.

Using Table 5, the cable length needed = $(1 \times 10 \times 2) + (12.5 \times 6 \times 2.6) = 215$

From Table 3, you would select the ADKS-1200 (240 feet of cable) to ensure complete coverage.

Note: If you are only treating one special roof area and the problem area is a significant distance from the downspout, you may wish to add extra cable to your estimation to account for the cable in the gutter.

EasyHeat™ ADKS Cable

Roof and Gutter De-Icing, Constant Wattage, Pre-Terminated. For Residential Applications.

Product Selection

Catalog Number	Description	Bags of Roof Clips Included	Carton Quantity	Carton Weight lb (kg)	UPC
ADKS100 ①	20 ft (6.1 m) length, 100 Watts	1	5	8 (3.6)	01362710969
ADKS150 ①	30 ft (9.1 m) length, 150 Watts	1	5	9 (4.1)	01362710970
ADKS300 ①	60 ft (18.3 m) length, 300 Watts	2	5	13 (5.9)	01362710971
ADKS400 ①	80 ft (24.4 m) length, 400 Watts	3	5	16 (7.3)	01362710972
ADKS500 ①	100 ft (30.5 m) length, 500 Watts	4	5	17 (7.7)	01362710973
ADKS600	120 ft (36.6 m) length, 600 Watts	4	2	10 (4.6)	01362710974
ADKS800	160 ft (48.8 m) length, 800 Watts	5	2	12 (5.4)	01362710975
ADKS1000	200 ft (61 m) length, 1000 Watts	7	2	15 (6.8)	01362710976
ADKS1200	240 ft (73.2 m) length, 1200 Watts	8	2	17 (7.7)	01362710977
RKCADKS	Starter assortment: one each of ①'s kits above	–	1 set	14 (6.4)	01362707042
RKFADKS	Assortment: two each of ①'s kits above; (1) RS2	–	1 set	27 (12.2)	01362707001
CSK12	Clips (19) and spacers (16)	–	10 bags	2 (0.9)	01362710814

① Individual cables are available as part of a kit, see RKCADKS or RKFADKS.

EasyHeat™ PSR Cable

Roof and Gutter De-Icing, Self-Regulating, Pre-Terminated. For Residential and Commercial Applications.

Product Overview

- PSR is a parallel resistance, self-regulating cable provided in pre-terminated lengths with factory sealed connections.
- These cables are a top-of-the line solution for abating roof, gutter and downspout ice dams.
- The self-regulating heating cable automatically varies its heat output as the surrounding temperature changes. Increasing when colder, decreasing when warmer.

Applications

- Suitable for shingle, slate, metal, wood and flat roofs with either plastic or metal gutters/downspouts.
- Commercial and residential roof and gutters prone to ice damming and dangerous icicles.
- Downspouts that freeze and clog.

Features

- 120 Vac and 240 Vac models available.
 - 120 Vac models have an integral three-wire plug with a pilot light.
 - 240 Vac models have a three wire pigtail.
- Pre-terminated lengths from 6 ft to 100 ft (1.83 m to 30.48 m); 8 Watts/ft in ice.
- Manufactured with a water-resistant TPE outer jacket.
- Cables are rated at 5 Watts per foot (0.30 m) at +50 °F (+10 °C).
- One year limited warranty.

Heating Cable Control Options and Power Connection

- 120 Vac cables should be plugged into a ground fault protected electrical receptacle.
- 240 Vac cables are designed to be directly connected into an appropriate electrical outlet box supplied by ground fault protected circuit.

Accessories

- Hanger kits and roof clips are available.
 - DSH Downspout Hanger
 - ZH-C Roof Clips and Spacers



Certifications

- UL Listed to Canadian Safety Standards and CSA Certified for ordinary locations.

Notes

- Per NEC and CEC requirements ALWAYS use a ground fault protection device (GFEP) to reduce the danger of fire from a damaged or improperly installed heating cable. Electrical fault currents caused by damaged or improperly installed cable MAY NOT BE LARGE ENOUGH to trip a conventional circuit breaker.
- Heating cables must be installed in compliance with all national, state/provincial and local codes. Check with your local electrical inspector for specific details.
- It is recommended that the circuit supplying the heating cable have ground fault protection; this is mandatory by electrical code for some applications in many regions. Consult an electrical inspector to determine the specific ground fault requirements for your application prior to installation.
- Do not alter the length of the heating cable — cable is factory sealed and alteration will result in risk of electrical fire or shock.
- If more than one heating cable is used on a single electrical circuit please refer to the maximum heater length per circuit breaker size chart. Make sure the total heating cable length does not exceed the length specified in this table.
- Minimum installation temperature for the heating cable set is -22 °F (-30 °C).
- Do not use extension cords.

Illustrated Features

Pilot Light

120 Vac models have a pilot light in the PSR plug, assures the system has power.

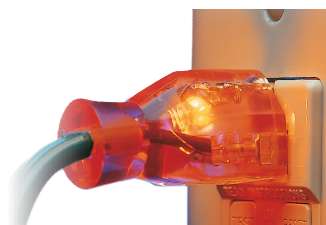

Three Wire Pigtail

240 Vac models have a three wire pigtail that should be directly connected into an appropriate electrical box supplied by ground fault protected circuit.



EasyHeat™ PSR Cable

Roof and Gutter De-Icing, Self-Regulating, Pre-Terminated. For Residential and Commercial Applications.

How To Determine The Length of Cable You Need

The total heating cable length for de-icing is determined by including all elements of the roof system that need protection. Use Tables 1 and 2 to determine the total length of cable. Usually one cable will be sufficient for both roof and gutter areas. For larger installations, use separate cables for roof area and gutter/downspout area.

Table 1: Determination of Total Cable Requirements

Model Number	Number of Cables
Roof Edge	From Table 2 based on eave overhang
Gutter	1 ft (30.48 cm) of cable/foot of gutter (if gutter is wider than 6 in (15.24 cm), use 2 traces)
Downspout	2 ft (60.96 cm) of cable/foot of downspout—cable is looped down and back
Roof Valley	6 ft (1.83 m) of cable/valley - loop 3 ft (0.91 m) up valley and back
Dormer Perimeter	1 ft (30.48 cm) of cable/foot of dormer perimeter

Table 2: Cable Length Factors vs. Eave Overhang

Eave Overhang E	Loop Height H	Length Factor Shingle Roof ① with Sawtooth Pattern	Length Factor Metal Roof ② with Loop Pattern
12 in (30.48 cm)	18 in (45.72 cm)	1.9	2.5
24 in (60.96 cm)	30 in (76.20 cm)	2.7	3.5
36 in (0.91 m)	42 in (1.07 m)	3.6	4.5
48 in (1.22 m)	54 in (1.37 m)	4.6	5.5

Cable length required = Length Factor × Roof Length (m/feet)

Notes:

① Typical shingle roof with sawtooth pattern.

② Typical metal roof with loop pattern spaced 24 in (61 cm) for other spacing these factors will need to be adjusted accordingly.

For other designs, contact your local EasyHeat sales representative.

Product Selection

Catalog Number	Description	Carton Quantity	Carton Weight lb (kg)	UPC
PSR1006	6 ft (1.83 m) length, 30 Watts, 120 Vac	5	4 (1.8)	013627069077
PSR1012	12 ft (3.66 m) length, 60 Watts, 120 Vac	5	7 (3.2)	013627069084
PSR1018	18 ft (5.49 m) length, 90 Watts, 120 Vac	5	8 (3.6)	013627069138
PSR1024	24 ft (7.32 m) length, 120 Watts, 120 Vac	5	10 (4.5)	013627069091
PSR1050	50 ft (15.24 m) length, 250 Watts, 120 Vac	5	17 (7.7)	013627069107
PSR1075	75 ft (22.86 m) length, 375 Watts, 120 Vac	2	10 (4.5)	013627069114
PSR1100	100 ft (30.48 m) length, 500 Watts, 120 Vac	2	13 (5.9)	013627069121
PSR2006	6 ft (1.83 m) length, 30 Watts, 240 Vac	5	4 (1.8)	013627068674
PSR2012	12 ft (3.66 m) length, 60 Watts, 240 Vac	5	7 (3.2)	013627068681
PSR2018	18 ft (5.49 m) length, 90 Watts, 240 Vac	5	9 (4.1)	013627068735
PSR2024	24 ft (7.32 m) length, 120 Watts, 240 Vac	5	10 (4.5)	013627068698
PSR2050	50 ft (15.24 m) length, 250 Watts, 240 Vac	5	16 (7.3)	013627068704
PSR2075	75 ft (22.86 m) length, 375 Watts, 240 Vac	2	9 (4.1)	013627068711
PSR2100	100 ft (30.48 m) length, 500 Watts, 240 Vac	2	13 (5.9)	013627068728

EasyHeat™ SR Trace™ Cable

Roof and Gutter De-Icing, Self-Regulating, Cut-to-Length. For Residential and Commercial Applications.

Product Overview

- SR Trace cable prevents costly damage to roofs caused by ice formation and snow accumulation in gutters, downspouts, and roof valleys.
- The self-regulating heating cable automatically varies its heat output as the surrounding temperature changes.

Applications

- Suitable for use on asphalt or wood shingles, metal roofing or “membrane” type roofing.
- Downspouts that freeze and clog.

Features

- Available for 120 and 240 Vac applications.
 - 240 Vac can be used for 208 or 277 Vac applications.
- Power densities of 5 Watts per foot (0.30 m) at +50 °F (+10 °C); 8 Watts per foot in ice.
- Available in cut-to-order lengths, convenient 250 ft (76.20 m) self dispensing reel boxes and 750 ft (228.6 m) master supply reels.
- Manufactured with a waterproof TPE outer jacket.
- Can be installed in dry or wet environments.
- Can be wrapped over itself (overlapped) minimizing the risk of damaging temperature-sensitive roof coating.
- One year limited warranty.

Related Products

- It is recommended that heating cables for roof and gutter deicing utilize controls that sense the presence of moisture and cold-temperature to optimize energy consumption. See *EasyHeat Roof and Gutter De-Icing Controls*.

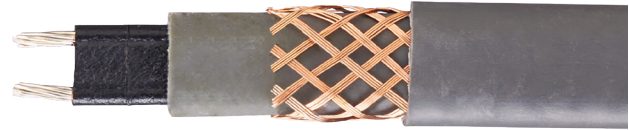

Accessories

- We offer specially designed kits that ease installation and connection of SR Trace products. See *EasyHeat SR Trace Connection Kits and Accessories*.

Certifications

- UL Listed to US and Canadian Safety Standards and CSA Certified.

Notes

- Per NEC and CEC requirements ALWAYS use a ground fault protection device (GFEP) to reduce the danger of fire from a damaged or improperly installed heating cable. Electrical fault currents caused by damaged or improperly installed cable MAY NOT BE LARGE ENOUGH to trip a conventional circuit breaker.
- Heating cables must be installed in compliance with all national, state/provincial and local codes. Check with your local electrical inspector for specific details.
- Do not twist the bus wires together at either end of the cable.
- All electrical connections in the system should be sealed against moisture.
- Do not expose heating cables to temperatures above their maximum ratings.
- Immediately replace any damaged heating cable or components.
- Classified areas (explosive dust or gas) require the use of special electrical components.

Illustrated Features

A special self-regulating core is at the center of the SR Trace cable. This core is conductive and adjusts according to the surrounding temperatures. When it is cold, the cable's core has many conductive paths that generate enough heat to keep the water flowing from the roof to the ground. As the surrounding temperature warms, there are fewer conductive paths and less heat is generated.

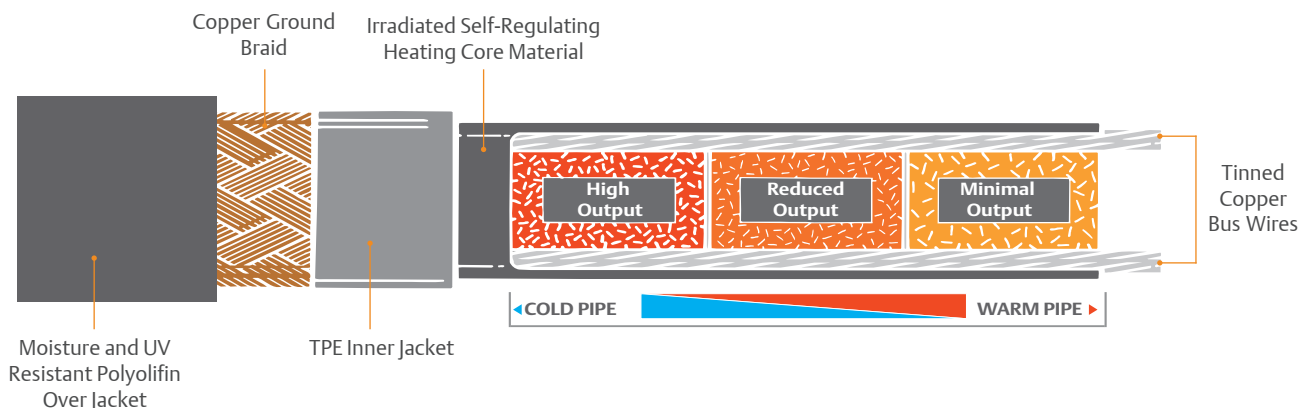

EasyHeat™ SR Trace™ Cable

Roof and Gutter De-Icing, Self-Regulating, Cut-to-Length. For Commercial and Residential Applications.

How To Determine The Length of Cable You Need

The total heating cable length for de-icing is determined by including all elements of the roof system that need protection. Use the following charts to determine the total length of cable.

- Step 1: Measure the roof length and enter it in "1" in the Cable Length Calculation Chart, Table 3.
- Step 2: Measure the overhang (shown in Figure 1) and determine the length multiplier for the type of roof, Table 2. Note: If the exact overhang is not listed, use the next larger size available in the chart.
- Step 3: Enter the number of dormers and the length of cable required to go up, over and down in "2" of Table 3.
- Step 4: Count the number of valleys and enter that number in "3" of Table 3.
- Step 5: Measure the length of the gutters and enter that length in "4" of Table 3. Note: this length will usually be the same as the roof length.
- Step 6: Count the number of downspouts and enter that in the first blank of "5" of Table 3.
- Step 7: Measure the height of the downspouts. Multiply that number by 2 for the length of the cable required to go down into downspout and back up to the gutter. Enter that number in the second blank of "5" of Table 3.
- Step 8: Determine the amount of cable needed for each type of roof feature by multiplying the two numbers on each line together and enter those numbers on the chart.
- Step 9: Sum the amount of cable needed for each type of roof feature to determine the total cable length. If this length exceeds the maximum circuit length of the cable, multiple runs will be needed. Although SR cable is cut to length, the amount of cable needed can be lengthened or shortened by increasing or decreasing the loop height.

Table 1: Cable Length Requirements Summary

Item	Cable Length Required (ft)	Comment
Roof Edge	From Table 2	Select from cable length required
Dormer Perimeter	1 ft per ft	1 ft of cable/ft of dormer perimeter
Roof Valley	6 ft minimum	Per valley (3 ft loop)
Gutter	1 ft per ft	1 Trace/6 in of gutter width
Downspout	2 ft per ft	Cable is looped down and back

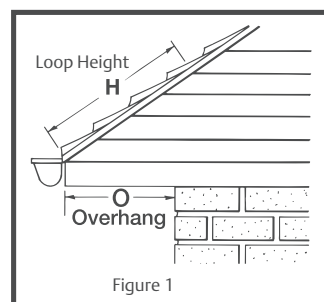

Figure 1

Table 2: Cable Length Factors vs. Roof Overhang

Eave Overhang "O"	Loop Height "H" = "O+6"	Multiplier	
		Length (ft) Factor Shingle Roof ①	Length (ft) Factor Metal Roof ②
12 in	18 in	1.9	2.5
24 in	30 in	2.7	3.5
36 in	42 in	3.6	4.5
48 in	54 in	4.6	5.5
Cable length required = Length Factor x Roof Length ③			

Notes:

- ① Standard shingle roof.
- ② Metal roof with two foot loop spacing.
- ③ Cable length calculated above does not include cable for gutter or downspout. For other designs, contact your local EasyHeat sales representative.

Table 3 Cable Length Calculation Chart

1 Roof	_____ x _____	= _____
	Length Multiplier	
2 Dormers	_____ x _____	= _____
	Number of up, over and down	
3 Valleys	_____ x _____ 6 ft	= _____
	Number of 3 ft up and 3 ft down	
4 Gutters	_____ x _____ 1 ft	= _____
	Length 1 ft cable/1 ft gutter	
5 Downspouts	_____ x _____	= _____
	Number of 2x height, up and down	
Total Cable Length =		_____
Sum of 1 – 5		

EasyHeat™ SR Trace™ Cable

Roof and Gutter De-Icing, Self-Regulating, Cut-to-Length. For Residential and Commercial Applications.

Product Selection

Catalog Number	Description	Carton Quantity	Carton Weight lb (kg)	UPC
SR51J	5 Watts per foot (0.30 m), 120 Vac, cut-to-order	1	0.057 (0.026) per foot	01362700877
SR51J250	250 ft (76.20 m) self-dispensing reel	1	20 (9.1)	01362706921
SR51J750	750 ft (228.60 m) self-dispensing reel	1	72 (32.7)	01362706922
SR52J	5 Watts per foot (0.30 m), 240 Vac, cut-to-order	1	0.057 (0.026) per foot	01362701021
SR52J250	250 ft (76.20 m) self-dispensing reel	1	20 (9.1)	01362706919
SR52J750	750 ft (228.60 m) self-dispensing reel	1	72 (32.7)	01362706920

Performance Information

Performance and Rating Data

Catalog Number	SR51J	SR52J		
Voltage (Vac)	120	208	240	277
Nominal Power Output in Ice (W/ft)	8.0	7.0	8.0	10.0
Nominal Power Output @ +50 °F (+10 °C)	5.0	5.0		
Maximum Single Cable Length ft (m)	191 (58.2)	381 (116.1)		
Minimum Installation Temperature °F (°C)	-40 (-40)	-40 (-40)		
Current Load (Amp/ft)				
at 0 °F (-18 °C) start-up	0.132	0.066		
at -20 °F (-30 °C) start-up	0.147	0.073		

Maximum Cable Length per Circuit in ft (m)

Breaker Size	SR51J			SR52J		
Start-up Temperature	+20 °F (-6 °C)	0 °F (-20 °C)	-20 °F (-30 °C)	+20 °F (-6 °C)	0 °F (-20 °C)	-20 °F (-30 °C)
15 Amp Breaker	125 (38.1)	115 (35.1)	100 (30.5)	250 (76.2)	225 (68.6)	205 (62.5)
20 Amp Breaker	170 (51.8)	150 (45.7)	135 (41.1)	335 (102.1)	300 (91.4)	270 (82.3)
30 Amp Breaker	250 (76.2)	225 (68.6)	205 (62.5)	500 (152.4)	455 (138.7)	405 (123.4)

EasyHeat™ SR Trace™ Connection Kits and Accessories

Roof and Gutter De-Icing. For Residential and Commercial Applications.

Product Overview

- These specially designed EasyHeat kits provide the right hardware for helping to install SR Trace self-regulating heating cables.

EHES Push-On End-Seal Kit

- Terminates end of all 3, 5, 8 Watt SR Trace heating cables.
- Easy push-on design allows for quick installation, forming a permanent connection.
- Used without heating gun for portability on any job site.
- Indoor/Outdoor approved for dry/wet roof and gutter use.
- Kit includes two (2) end seals.

DSH Downspout Hanger

- Supports heating cable and maintains cable spacing where it enters and exits a downspout.
- Each kit contains two hangers.

SRP Power/Splice Connection Kit

- Provides heat shrink tubing based power connection for one or two cables within customer supplied junction box.
- Provides two (2) heat shrinkable end seals.
- Allows for heating cable to heating cable splice using a customer supplied junction box.

SRES End-Seal Kit

- Provides heat shrink tubing based end seal for a heating cable circuit.
- Each kit contains 5 end seals.

SRSRG Roof and Gutter In-Line Splice Kit

- Provides heat shrink tubing based materials necessary to perform a splice of two roof and gutter heating cables.
- Each kit contains one splice.

SRPCRG Power Connection Kit

- Provides heat shrink tubing based power connection to a customer supplied junction box.
- This entry seal kit provides a watertight entry connection.
- Includes cable seals for power connection and end terminations for a single heating cable.

GFST1 Line Plug

- Plug in power connection kit with ground fault circuit protection.
- Rated for 15 Amp circuit breaker at 120 Vac.

ZH-C Roof Clips and Spacers

- Attaches heating cable to roof and also to maintain cable spacing in gutters and downspouts.
- Each kit has components for 50 roof clips or 25 cable spacers.

SRM-2 Silicone Boot Power/End-Seal Connection Kit

- Allows on-site cut cables to be terminated without the use of a heat gun.
- Used to connect power to the cable inside a customer supplied junction box and to terminate the other end of the cable.
- Easy and quick installation.
- Compatible with SR Trace and RG Roof and Gutter Cables.
- Each kit contains 2 power-connection boots, 2 end-seal boots and 1 tube of adhesive.

Note: All kits have a one year limited warranty.



EHES Push-On End-Seal Kit



DSH Downspout Hanger



SRP Power/Splice Connection Kit



SRES End-Seal Kit



SRSRG Roof and Gutter In-Line Splice Kit



SRPCRG Power Connection Kit



GFST1 Line Plug



ZH-C Roof Clips and Spacers



SRM-2 Silicone Boot Power/End-Seal Connection Kit

EasyHeat™ SR Trace™ Connection Kits and Accessories

Roof and Gutter De-Icing. For Residential and Commercial Applications.

Certifications

- The EHES Push-On End-Seal kit and GFST1 Line Plug are UL listed to both US and Canadian standards.
- The SRP power/end connection kit, SRSRG cable splice kit, SRES end seal kit UL Listed and CSA Certified.

Product Selection

Catalog Number	Description	Carton Quantity	Carton Weight lb (kg)	UPC
EHES	Push-On End-Seal kit	1	2 (0.9)	013627005662
DSH	Downspout hanger kit (2)	2	3 (1.4)	01362706974
SRP	Power/end connection kit	5	3 (1.4)	01362706972
SRPC ①	Heat shrink power/end connection kit	5	3 (1.4)	01362706972
SRSRG	Cable splice kit	1	2 (0.9)	01362706976
SRPCRG	Power connection kit	1	2.2 (1)	01362703934
SRES	End seal kit (5)	5	2 (0.9)	01362706968
GFST1	GFCI line plug to heating cable	1	1 (0.5)	01362706965
ZHC	Roof clips (50) or spacers (25)	5	4 (1.8)	01362706978
SRM2	Silicone Boot Power/End-Seal Connection Kit	1	0.2 (0.1)	013627005297

① Available exclusively for Canada.

EasyHeat™ RG Roof and Gutter Cable

Roof and Gutter De-Icing, Self-Regulating, Cut-to-Length. For Commercial Applications.

Product Overview

- The RG cable prevents costly damage to roofs caused by ice formation and snow accumulation in gutters, downspouts, and roof valleys.
- The self-regulating heating cable automatically varies its heat output as the surrounding temperature changes.

Applications

- Creates pathways for melt water to continuously flow from the roof to the ground, minimizing the opportunities for damage caused by accumulating ice on an angled/flat commercial roof.
- Prevents gutters and downspouts from clogging and overflowing due to ice buildup.
- Suitable for use on pitched asphalt or wood shingles, metal roofing or flat “membrane” type roofing.

Features

- 12 Watts of heavy-duty heating power, quickly and easily melts through frozen ice buildups.
- Rated 12 W/ft (40 w/m) in embedded snow and ice.
- Keeps melt water pathways open in larger commercial gutters, drains and downspouts.
- 16 AWG bus wires.
- Tinned copper grounding braid.
- Waterproof, flame retardant and UV sun-resistant, polyolefin outer jacket withstands harsh weather conditions.
- Two thermoplastic inner jackets for dielectric strength, abrasion resistance and additional core protection.
- Maximum single cable lengths up to 370 ft (112.8 m).
- 120 or 208-277 Vac operating voltage.
- UL approved for indoor/outdoor environments.
- Reels are cut to customer specification, in continuous lengths up to 1,000 ft (300 m).
- The self-regulating design allows the cable to be overlapped without producing hot spots. Will not damage temperature sensitive roof coatings.
- One year limited warranty.

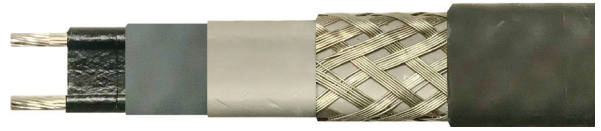

Related Products

- It is recommended that heating cables for roof and gutter deicing utilize controls that sense the presence of moisture and cold-temperature to optimize energy consumption. See *EasyHeat Roof and Gutter De-Icing Controls*.

Accessories

- We offer specially designed kits that ease installation and connection of RG Series Cable products. See *EasyHeat RG Roof and Gutter Cable Connection Kits and Accessories*.

Certifications

- UL Listed to US and Canadian Safety Standards for ordinary locations.

Notes

- *Per NEC and CEC requirements ALWAYS use a ground fault protection device (GFEP) to reduce the danger of fire from a damaged or improperly installed heating cable. Electrical fault currents caused by damaged or improperly installed cable MAY NOT BE LARGE ENOUGH to trip a conventional circuit breaker.*
- *Heating cables must be installed in compliance with all national, state/provincial and local codes. Check with your local electrical inspector for specific details.*
- *All electrical connections in the system should be sealed against moisture.*
- *Do not expose heating cables to temperatures above their maximum ratings of +175 °F (+80 °C).*
- *Immediately replace any damaged heating cable or components.*
- *Classified areas (explosive dust or gas) require the use of special electrical components.*
- *Refer to product instruction manual for proper installation methods.*

Illustrated Features

A special self-regulating core is at the center of the RG Series cable. This core is conductive and adjusts according to the surrounding temperatures. When it is cold, the cable's core has many conductive paths that generate enough heat to keep the water flowing from the roof to the ground. As the surrounding temperature warms, there are fewer conductive paths and less heat is generated.

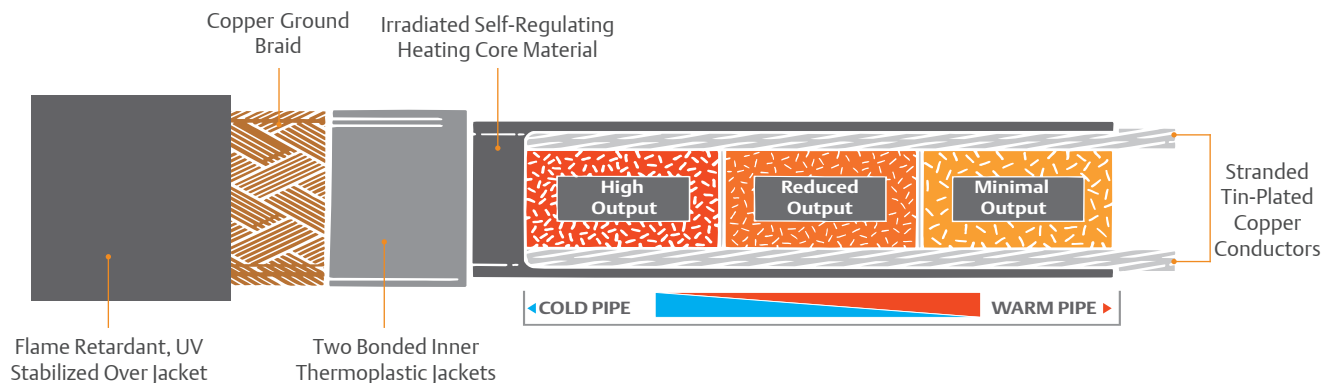

EasyHeat™ RG Roof and Gutter Cable Length Calculator

Roof and Gutter De-Icing, Self-Regulating, Cut-to-Length. For Commercial Applications.

How To Determine The Length of Cable You Need

The total heating cable length for de-icing is determined by including all elements of the roof system that need protection. Use the following charts to determine the total length of cable.

- Step 1: Measure the roof length and enter it in "1" in the Cable Length Calculation Chart, Table 3.
- Step 2: Measure the overhang (shown in Figure 1), if applicable, and determine the length multiplier for the type of roof, Table 2. Once Overhang Multiplier is identified, enter the multiplier on the second blank in "1".
Note: If the exact overhang is not listed, use the next larger size available in the chart.
- Step 3: Measure the length of the gutters and enter that length in "4" of Table 3. Note: this length will usually be the same as the roof length.
- Step 4: Count the number of downspouts or scuppers and enter that in the first blank of "5" of Table 3.
- Step 5: Measure the height of the downspouts or depth of scuppers. Multiply that number by 2 for the length of the cable required to go down into downspout and back up to the gutter. Enter that number in the second blank of "5" of Table 3.
- Step 6: Count the number of drains and enter that in the first blank of "6" of Table 3. Measure the height of the unheated space for the drains. Multiply that number by 2 for the length of cable required to go down into the drain and back up. Enter that number in the second blank of "6" of Table 3 (note you will need to add 30 to this number before multiplying it by the number of drains).
- Step 7: Enter the number of dormers and the length of cable required to go up, over and down in "2" of Table 3. Skip step for flat roofs.
- Step 8: Count the number of valleys and enter that number in "3" of Table 3. Skip step for flat roofs.
- Step 9: Determine the amount of cable needed for each type of roof feature by multiplying the two numbers on each line together and enter those numbers on the chart.
- Step 10: Sum the amount of cable needed for each type of roof feature to determine the total cable length. If this length exceeds the maximum circuit length of the cable, multiple runs will be needed. Although RG cable is cut to length, the amount of cable needed can be lengthened or shortened by increasing or decreasing the loop height.

Table 1: Cable Length Requirements Summary

Item	Cable Length Required (ft)	Comment
Roof Edge	From Table 2	Select from cable length required
Dormer Perimeter	1 ft per ft	1 ft of cable/ft of dormer perimeter
Roof Valley	6 ft minimum	Per valley (3 ft loop)
Gutter	1 ft per ft	1 Trace/6 in of gutter width
Downspout or Scupper	2 ft per ft	Cable is looped down and back
Drains	2 ft per ft + 30 ft	Cable is looped down and back plus cable around drain entry

Table 2: Cable Length Factors vs. Roof Overhang

Eave Overhang "O"	Loop Height "H" = "O+6"	Multiplier	
		Length (ft) Factor Shingle Roof ①	Length (ft) Factor Metal Roof ②
12 in	18 in	1.9	2.5
24 in	30 in	2.7	3.5
36 in	42 in	3.6	4.5
48 in	54 in	4.6	5.5
Cable length required = Length Factor x Roof Length ③④			

Notes:

- ① Standard shingle roof.
- ② Metal roof with two foot loop spacing.
- ③ Cable length calculated above does not include cable for gutter or downspout. For other designs, contact your local EasyHeat sales representative.
- ④ Membrane/flat roofs use length factor of 1.9 to account for cable loop for roof edges and potential buffer.

Flat Roof

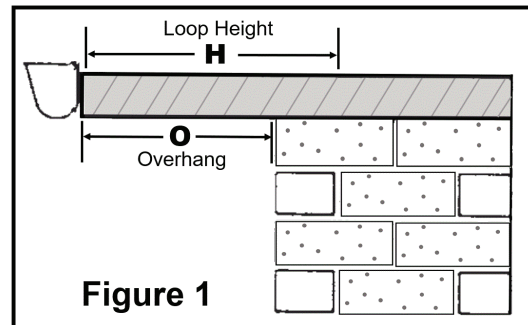

Figure 1

Table 3: Cable Length Calculation Chart

1 Roof	_____ x _____	= _____
	Length Multiplier	
2 Gutters	_____ x _____	= _____
	Length 1 ft cable/1 ft gutter	
3 Downspouts or Scuppers	_____ x _____	= _____
	Number of 6 ft 2x height, up and down	
4 Drains	_____ x (_____ 1 ft + 30 ft)	= _____
	Number of 2x height	
5 Dormers	_____ x _____	= _____
	Number of up, over and down	
6 Valleys	_____ x _____	= _____
	Number of 3 ft up and 3 ft down	
Total Cable Length = _____		
Sum of 1 – 6		

Note: For flat roofs, skip steps 5 and 6.

EasyHeat™ RG Roof and Gutter Cable

Roof and Gutter De-Icing, Self-Regulating, Cut-to-Length. For Commercial Applications.

Product Selection

Catalog Number	Description	Carton Weight lb (kg)	UPC
RG-1	EasyHeat RG Self-Regulating, 12 W Roof and Gutter Deicing Cable, 120 V	0.1 per foot (0.17 per meter)	01362700509
RG-2	EasyHeat RG Self-Regulating, 12 W Roof and Gutter Deicing Cable, 240 V	0.1 per foot (0.17 per meter)	01362700513

Performance Information

Performance and Rating Data

Catalog Number	RG-1	RG-2		
Voltage (Vac)	120	208	240	277
Nominal Power Output in Ice (W/ft)	12.0	10.0	12.0	15.0
Nominal Power Output @ +50 °F (+10 °C)	5.0	5.0		
Maximum Single Cable Length ft (m)	185	370		
Minimum Installation Temperature °F (°C)	-22 (-30)	-22 (-30)		
Current Load (Amp/ft)				
at 0 °F (-20 °C) start-up	0.195	0.097		
at -20 °F (-30 °C) start-up	0.220	0.110		

Maximum Cable Length per Circuit in ft (m)

Breaker Size	RG-1			RG-2		
	+20 °F (-6 °C)	0 °F (-20 °C)	-20 °F (-30 °C)	+20 °F (-6 °C)	0 °F (-20 °C)	-20 °F (-30 °C)
15 Amp Breaker	90 (27.4)	75 (22.9)	70 (21.3)	175 (53.3)	155 (47.2)	135 (41.1)
20 Amp Breaker	120 (36.6)	105 (32.1)	90 (27.4)	235 (71.6)	205 (62.5)	180 (54.9)
30 Amp Breaker	175 (53.3)	155 (47.2)	135 (41.1)	355 (108.2)	310 (94.5)	275 (83.8)
40 Amp Breaker	235 (71.6)	205 (62.5)	180 (54.9)	470 (143.3)	410 (125.0)	365 (111.3)

EasyHeat™ RG Roof and Gutter Cable Connection Kits and Accessories

Roof and Gutter De-Icing. For Residential and Commercial Applications.

Product Overview

- These specially engineered roof and gutter kits provide the right accessories to ensure the hassle-free installation of RG self-regulating heating cables in roof and gutter applications.

DSH Downspout Hanger

- Supports heating cable and maintains cable spacing where it enters and exits a downspout.
- Each kit contains two hangers.



DSH Downspout Hanger

ZH-C Roof Clips and Spacers

- Attaches heating cable to roof and also to maintain cable spacing in gutters and downspouts.
- For use on angled, shingled roofs, attach with nails or other appropriate fasteners.
- For use on flat, membrane style roofs, attach with appropriate construction adhesive.
- Each kit has components for 50 roof clips or 25 cable spacers.



ZH-C Roof Clips and Spacers

ALT1 Aluminum Heat Transfer Tape

- Saves energy by transferring heat to other conductive roof components and utilizing all heat energy.
- Used on plastic/composite roof components to evenly distribute heat.
- Length of 180 feet (55 m).
- Width of 2 inches (5 cm).



ALT1 Aluminum Heat Transfer Tape

SRM-2 Silicone Boot Power/End-Seal Connection Kit

- Allows on-site cut cables to be terminated without the use of a heat gun.
- Used to connect power to the cable inside a customer supplied junction box and to terminate the other end of the cable.
- Easy and quick installation.
- Compatible with SR Trace and RG Roof and Gutter Cables.
- Each kit contains 2 power-termination boots, 2 end-seal boots and 1 tube of adhesive.



SRM-2 Silicone Boot Power/End-Seal Connection Kit

SRES End Seal Kit

- Provides heat shrink tubing based end seal for a heating cable circuit.
- Use of heat gun required.
- Each kit contains 5 end seals.



SRES End Seal Kit

SRSRG Roof and Gutter In-Line Splice Kit

- Provides heat shrink tubing based materials necessary to perform a splice of two roof and gutter heating cables.
- Use of heat gun required.
- Each kit contains one splice.



SRSRG Roof and Gutter In-Line Splice Kit

SRPCRG Power/End Connection Kit

- Provides heat shrink tubing based power connection to a customer supplied junction box.
- This entry seal kit provides a watertight entry connection.
- Includes cable seals for power connection and end terminations for a single heating cable.
- Use of heat gun required.



SRPCRG Power/End Connection Kit

Certifications

- The SRPCRG power/end connection kit, SRSRG cable splice kit, SRM-2 connection kit, and SRES end seal kit are UL Listed and CSA Certified for use in the US and Canada.

Note: All kits have a one year limited warranty.

EasyHeat™ RG Roof and Gutter Cable Connection Kits and Accessories

Roof and Gutter De-Icing. For Residential and Commercial Applications.

Product Selection

Catalog Number	Description	Carton Quantity	Carton Weight lb (kg)	UPC
DSH	Downspout hanger kit (2)	2	3 (1.4)	01362706974
ZHC	Roof clips (50) or spacers (25)	5	4 (1.8)	01362706978
ALT1	Aluminum heat transfer tape (180 ft/55 m)	1	2 (0.9)	01362706830
SRM-2	Silicone Boot Power (2)/End-Seal (2) Connection Kit	1	0.2 (0.1)	013627005297
SRES	End seal kit (5)	5	2 (0.9)	01362706968
SRSRG	Cable splice kit (1)	1	2 (0.9)	01362706976
SRPCRG	Power connection kit (1)	1	2.2 (1)	01362703934

EasyHeat™ Roof and Gutter De-Icing Controls

Roof and Gutter De-Icing. For Residential and Commercial Applications.

Product Overview

- EasyHeat roof and gutter de-icing controls are designed to sense both moisture and temperature, and manufactured for use with our roof and gutter de-icing heating cables.

Roof Sentry RS2

- The Roof Sentry RS2 unit automatically controls operation of ADKS and 120 Vac PSR electric roof de-icing cables.
- Automatic control requires two conditions to be present before it energizes roof de-icing cable:
 - Cold temperatures below +40 °F (+40 °C).
 - Presence of run-off water from the roof in contact with the sensor wire.
- Measures both temperature and moisture to turn the system on or off in response to changing weather conditions.
- Rated at 10 Amps at 120 Vac.
- Supplied with 10 ft (3 m) of sensor wire.
- Operating temperature: -40 °F to +150 °F (-40 °C to +65 °C)
- Storage temperature: -40 °F to +150 °F (-40 °C to +65 °C)
- One year limited warranty.



Roof Sentry RS2



GC1 Controller



MSC1 Controller

GC1 Controller

- Designed to energize the heating cable only when moisture conditions exist and there is a risk of freezing.
- For use with all SR, RG and 240 Vac PSR heating cables.
- Controller applies power to the heating cable if the temperature is below +38 °F (+3 °C).
- Built in temperature sensor. Includes MSG1 Moisture Sensor.
- Voltage: 120, 208, 240 or 277 Vac
- Current: 24 Amps maximum at 277 Vac
- Operating temperature: -40 °F to +150 °F (-40 °C to +65 °C)
- Storage temperature: -40 °F to +150 °F (-40 °C to +65 °C)
- One year limited warranty.

MSC1 Controller

- Commercial grade unit suitable for controlling snow and ice melting in gutters and downspouts.
- For use with all SR and RG heating cables.
- MSC1 control panel is capable of monitoring snow/ice accumulation in three separate snow melting application zones and issuing separate control signals for each zone.
- NEMA 4, 4X enclosure for commercial/industrial indoor applications.
- LCD display, programming and associated indicator lights, confirming the operation of each zone.
- Includes TS1 temperature sensor.
- Voltage: 120 Vac
- Operating temperature: -4 °F to +160 °F (-20 °C to +70 °C)
- Storage temperature: -4 °F to +185 °F (-20 °C to +85 °C)
- One year limited warranty.

Certifications

- RS2 is CSA Certified.
- MSC1 and GC1 controllers are UL Listed to US and Canadian Safety Standards.

EasyHeat™ Roof and Gutter De-Icing Controls

Roof and Gutter De-Icing, MSC1 Control Sensors. For Residential and Commercial Applications.

Product Overview

- EasyHeat roof and gutter de-icing control sensors are designed to sense moisture or temperature, and are manufactured for use with our roof and gutter de-icing controls.

MSG1 Gutter Moisture Sensor

- Detects moisture on roofs and in gutters.
- Supplied with 10 ft (3 m) of connection wire.
- Roof moisture detection is made with the unique sensor wire design.
- Gutter moisture detection is made by the sensing grid on the bottom on the housing.
- The combination roof and gutter detection system assures detection of moisture and minimizes potential for ice dam formation.
- Operating temperature: -40 °F to +160 °F (-40 °C to +70 °C)
- Storage temperature: -40 °F to +160 °F (-40 °C to +70 °C)
- Voltage: 24 Vac
- Current: 500 mA



MSG1 Gutter Moisture Sensor

MSA1 Aerial Moisture Sensor

- Detects falling or blowing snow coming in contact with the sensor grid, then sends a signal to the MSC-1 to energize heating equipment.
- Supplied with 10 ft (3 m) of connection wire that can be extended up to 500 ft (152 m) with an appropriately rated 18-20 AWG 3 wire unshielded or shielded stranded cable.
- Voltage: 24 Vac
- Current: 500 mA
- Operating temperature: -40 °F to +160 °F (-40 °C to +70 °C)
- Storage temperature: -40 °F to +160 °F (-40 °C to +70 °C)
- One year limited warranty.



MSA1 Aerial Moisture Sensor

TS1 Temperature Sensor

- Replacement TS1 temperature sensor.
- Measures ambient temperatures.
- Supplied with 10 ft (3 m) of connection wire which can be extended up to 500 ft (152 m) with an appropriately rated 18-20 AWG 3 wire unshielded or shielded stranded cable.
- Voltage: 120 Vac
- Current: 16 mA
- Operating temperature: -40 °F to +150 °F (-40 °C to +65 °C)
- Storage temperature: -49 °F to +160 °F (-45 °C to +70 °C)
- One year limited warranty.



TS1 Temperature Sensor

Certifications

- UL Listed to US and Canadian Safety Standards.

EasyHeat™ Roof and Gutter De-Icing Controls

Roof and Gutter De-Icing. For Residential and Commercial Applications.

Product Selection

Catalog Number	Description	Carton Quantity	Carton Weight lb (kg)	UPC
RS2	Roof Sentry control	5	10 (4.5)	01362709862
GC1	Rain/snow sensor controller	1	3 (1.4)	01362701508
MSC1	Controller (with TS1)	1	8.5 (3.9)	01362701500
MSCG1 ①	Controller, TS1, MSG1	1	11 (5.0)	01362701507
MSG1	Gutter sensor	1	2 (0.9)	01362701502
MSA1	Aerial sensor	1	2 (0.9)	01362701501
TS1	Replacement temperature sensor	1	1.5 (0.7)	01362701504

① System package for MSC.



Snow Melting

In concrete, asphalt or under paving stone, you can count on Emerson's EasyHeat™ snow melting systems to clear the way. Highly efficient and more economical than most other snow and ice removal methods, our snow melting systems automatically eliminate snow and freezing rain on contact, helping to keep the surface clear and maintenance free, 24 hours a day, 7 days a week.

EasyHeat™ Snow Melting Product Selection Guide

Criteria	Standard Snow Mats	Standard Step Mats	Custom Snow Mats	SMK Cables	MI Trace
1. What is the area of application?					
Typical Application	Residential Commercial	Residential Commercial	Residential Commercial	Residential Commercial	Commercial Industrial
2. What is the material of the surface floor?					
Pavers	✓	✓	✓	✓	✓
Concrete	✓	✓	✓	✓	✓
Asphalt	✓	✓	✓	–	✓
3. What are the layout options?					
Layout Options	Rectangular shape: Widths: 18 in (0.46 m), 36 in (0.91 m) Lengths: 4.5 ft to 30 ft (1.37 m to 9.14 m)	Rectangular Shape: 2 or 3 steps Widths: 3 ft (0.91 m), 6 ft (1.83 m) Depth: 8 in (0.20 m)	Built to Customer Specification Max Width: 72 in (1.83 m) Max Length: 25 ft (7.62 m)	Custom shape within a specific area	Built to customer specification
4. What is the available supply voltage?					
Supply Voltage (Vac)	208, 240, 277, 480 347 (for Canada)	208, 240, 277, 480 347 (for Canada)	120, 208, 240, 277, 480 347 (for Canada)	208, 240	120, 208, 240, 277, 480 347 (for Canada)
5. What is the power rating?					
Power Rating	50 Watts/ft ²	50 Watts/ft ²	Min: 40 Watts/ft ² Max: 72 Watts/ft ²	46 Watts/ft ² @ 3 in (76.2 mm) spacing 35 Watts/ft ² @ 4 in (101.6 mm) spacing	Min: 40 Watts/ft ² Max: 88 Watts/ft ² ①
6. What is the cold lead length?					
Standard Cold Lead Length	20 ft (6.10 m)	20 ft (3.05 m)	20 ft (6.10 m) Max: 125 ft (38.10) [14 AWG] Max: 150 ft (45.72 m) [10 AWG]	20 ft (6.10 m)	Min: 7 ft (2.13 m) Max: ①

✓ Applicable

– Not Applicable

① Verify with your local EasyHeat sales representative.

EasyHeat™ Sno*Melter™ Mats

Snow Melting, Constant Wattage, Hard-wired. For Residential and Commercial Applications.

Product Overview

- Sno*Melter Mats are easy to install in concrete, asphalt or under pavers. They are a simpler and safer method of removing surface snow at a home or business.
- When connected to optional controls that detect moisture and freezing temperatures, they start working when the snow starts to fall to help prevent the accumulation of snow and ice.
- Standard sized Sno*Melter Mats can easily be combined and tailored for a variety of configurations.
- Custom Sno*Melter Mats are also available, specifically built for project designs that require unique shapes and sizes.

Applications

- Prevention of snow and ice accumulation on steps, walkways, driveways, parking areas, loading docks and roads.

Features

- Standard Sno*Melter Mats:
 - Available in 18 in and 36 in (0.46 m and 0.91 m) widths.
 - Engineered to provide 50 W/ft² in voltages 208 Vac, 240 Vac, 277 Vac, 347 Vac, 480 Vac and 600 Vac.
 - Mats are supplied with 20 ft (6 m) cold leads as standard, longer lead lengths are optional.
- Custom Sno*Melter Mats:
 - Available in outputs up to 72 W/ft² in voltages up to 600 Vac.
 - Mats are supplied with standard 20 ft (6 m) cold leads, longer lengths available. Contact your local EasyHeat representative for details.
- Step Sno*Melter Mats:
 - Come standard in 2- or 3-step models.
 - Available in 3 ft or 6 ft (0.91 m or 1.83 m) tread width with 8 in (0.20 m) risers.
 - Engineered to provide 50 W/ft² and are supplied with 20 ft (6 m) cold leads.
 - Custom step mats are available for nonstandard power densities up to 72 W/ft², voltage, cold lead lengths and size needs.
- One year limited warranty.

Ordering Information

- We can assist you to determine the appropriate custom Sno*Melter Mat for your application. Contact your local EasyHeat representative for details.

Related Products

- It is recommended that a snow melting controller be used to provide reliable, automatic and economical operation of embedded snow melting systems. See *EasyHeat Snow Melting Controls*.

Accessories

- EasyHeat offers a variety accessories that can be used with our Sno*Melter Mats. See *EasyHeat Snow Melting Accessories*.

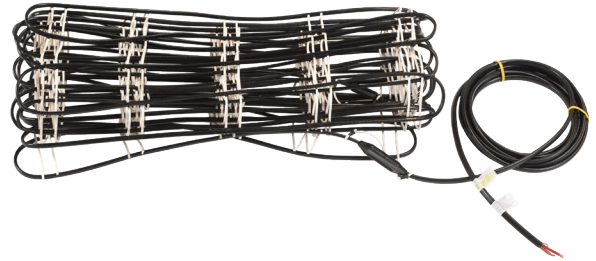

Certifications

- UL Listed and CSA Certified.

Notes

- Per NEC and CEC requirements ALWAYS use a ground fault protection device (GFPE) to reduce the danger of fire from a damaged or improperly installed heating cable. Electrical fault currents caused by damaged or improperly installed cable MAY NOT BE LARGE ENOUGH to trip a conventional circuit breaker.
- Heating cables must be installed in compliance with all national, state/provincial and local codes. Check with your local electrical inspector for specific details.
- Never allow the heating cables of the mats to touch, cross or overlap each other at any point.
- All installations 55 W/ft² and under do not require a thermostat.
- All installations 56-75 W/ft² require a high limit UL Listed and CSA Certified thermostat, set at maximum +41 °F (+5 °C).
- For widths over 72 in (1.83 m) up to 144 in (3.66 m), order mats twice as long, half as wide, cut and double back.
- Minimum installation temperature is +32 °F (0 °C).

EasyHeat™ Sno*Melter™ Mats

Snow Melting, Constant Wattage, Hard-wired. For Residential and Commercial Applications.

Illustrated Features

Sno*Melter Mats are comprised of a single length of dual conductor heating cable formed into a predetermined shape and secured in this shape by polymer carrier strands fused to the cable. The heating cable has a resistive conductor core, insulated with thermoplastic compound and an inner nylon jacket. A copper mesh is braided over the inner nylon jacket to provide a means for grounding the heating element. An additional jacket of polyvinyl chloride insulation is extruded over the copper braid. The heating cable and the cold lead are factory assembled with a waterproof molded splice connection.

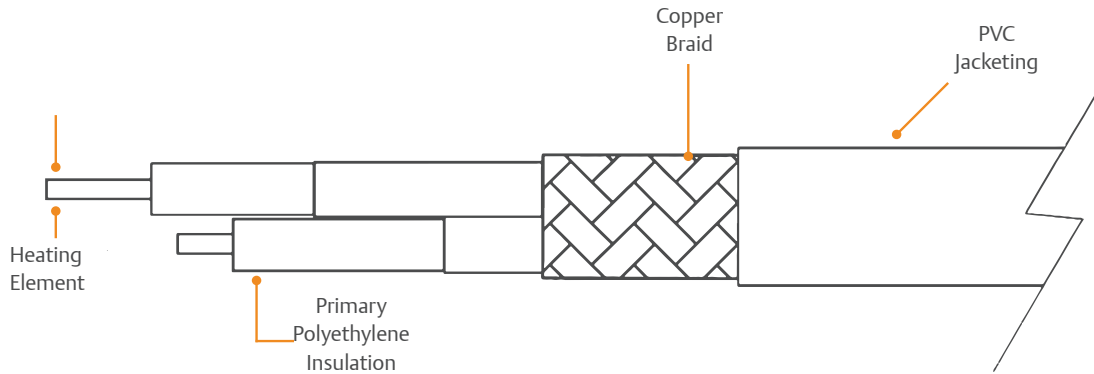

Mat Shape Configurations

Standard Sno*Melter™ Mats may be tailored to follow the contours of curves and other obstructions by making a series of cuts to the mat carrier strands. Extreme care should be exercised to prevent cutting the mat heating cable during this operation. The number of cuts required will depend upon the length of the mat and the radius of the curve.

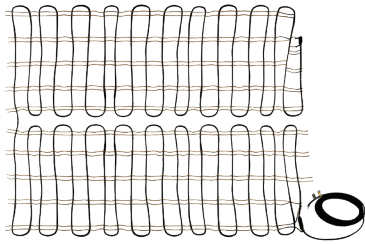

Increase Width

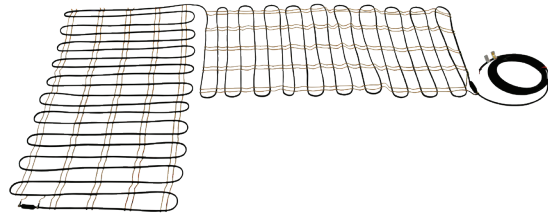

Corners

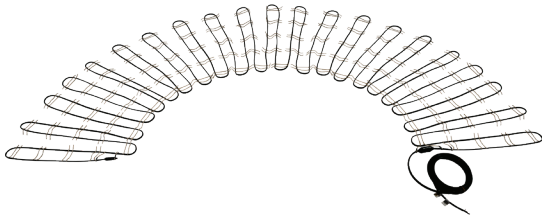

Curves

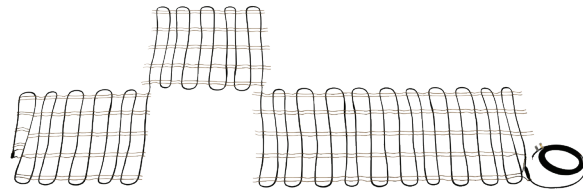

Around Obstacles

EasyHeat™ Sno* Melter™ Mats

Snow Melting, Constant Wattage, Hard-wired. For Residential and Commercial Applications.

Standard Sno* Melter Mats Product Selection

Catalog Number	Mat Length ft (m)	Mat Width in (m)	Power Watts	Vac	Carton Quantity	Carton Weight lb (kg)	UPC
G04X36250D	4 (1.22)	36 (0.91)	600	240	1	5.7 (2.6)	01362718371
G04X36250DNL14 ①	4 (1.22)	36 (0.91)	600	240	1	5.7 (2.6)	01362718372
G04X36450D	4 (1.22)	36 (0.91)	600	480	1	5.7 (2.6)	01362718517
G04X36450DNL14 ①	4 (1.22)	36 (0.91)	600	480	1	5.7 (2.6)	01362718483
G04X36750D	4 (1.22)	36 (0.91)	600	277	1	5.1 (2.3)	01362718470
G04X36750DNL14 ①	4 (1.22)	36 (0.91)	600	277	1	5.1 (2.3)	01362718425
G04X36850D	4 (1.22)	36 (0.91)	600	208	1	5.7 (2.6)	01362718373
G04X36850DNL14 ①	4 (1.22)	36 (0.91)	600	208	1	5.7 (2.6)	01362718374
G05X18250D	5 (1.52)	18 (0.46)	375	240	1	4.4 (2.0)	01362718375
G05X18250DNL14 ①	5 (1.52)	18 (0.46)	375	240	1	4.4 (2.0)	01362718378
G05X18450D	5 (1.52)	18 (0.46)	375	480	1	4.8 (2.2)	01362718380
G05X18450DNL14 ①	5 (1.52)	18 (0.46)	375	480	1	4.8 (2.2)	01362718381
G05X18750D	5 (1.52)	18 (0.46)	375	277	1	4.8 (2.2)	01362718382
G05X18750DNL14 ①	5 (1.52)	18 (0.46)	375	277	1	4.8 (2.2)	01362718404
G05X18850D	5 (1.52)	18 (0.46)	375	208	1	4.4 (2.0)	01362718409
G05X18850DNL14 ①	5 (1.52)	18 (0.46)	375	208	1	4.4 (2.0)	01362718496
G05X36250D	5 (1.52)	36 (0.91)	750	240	1	6.8 (3.1)	01362718407
G05X36250DNL14 ①	5 (1.52)	36 (0.91)	750	240	1	6.8 (3.1)	01362718448
G05X36450D	5 (1.52)	36 (0.91)	750	480	1	6.4 (2.9)	01362718518
G05X36450DNL14 ①	5 (1.52)	36 (0.91)	750	480	1	6.4 (2.9)	01362718410
G05X36750D	5 (1.52)	36 (0.91)	750	277	1	6.8 (3.1)	01362718455
G05X36750DNL14 ①	5 (1.52)	36 (0.91)	750	277	1	6.8 (3.1)	01362718428
G05X36850D	5 (1.52)	36 (0.91)	750	208	1	6.4 (2.9)	01362718489
G05X36850DNL14 ①	5 (1.52)	36 (0.91)	750	208	1	6.4 (2.9)	01362718502
G06X18250D	6 (1.85)	18 (0.46)	450	240	1	5.2 (2.4)	01362718395
G06X18250DNL14 ①	6 (1.85)	18 (0.46)	450	240	1	5.2 (2.4)	01362718414
G06X18450D	6 (1.85)	18 (0.46)	450	480	1	4.8 (2.2)	01362718509
G06X18450DNL14 ①	6 (1.85)	18 (0.46)	450	480	1	4.8 (2.2)	01362718476
G06X18750D	6 (1.85)	18 (0.46)	450	277	1	4.8 (2.2)	01362718460
G06X18750DNL14 ①	6 (1.85)	18 (0.46)	450	277	1	4.8 (2.2)	01362718416
G06X18850D	6 (1.85)	18 (0.46)	450	208	1	6.7 (3.0)	01362718405
G06X18850DNL14 ①	6 (1.85)	18 (0.46)	450	208	1	6.7 (3.0)	01362718497
G07X18250D	7 (2.13)	18 (0.46)	525	240	1	5.1 (2.3)	01362718396
G07X18250DNL14 ①	7 (2.13)	18 (0.46)	525	240	1	5.1 (2.3)	01362718440
G07X18450D	7 (2.13)	18 (0.46)	525	480	1	5.1 (2.3)	01362718510

① Other cold lead lengths available; To order, add "NL" to the part number, then specify desired length in feet and inches.

EasyHeat™ Sno* Melter™ Mats

Snow Melting, Constant Wattage, Hard-wired. For Residential and Commercial Applications.

Standard Sno* Melter Mats Product Selection

Catalog Number	Mat Length ft (m)	Mat Width in (m)	Power Watts	Vac	Carton Quantity	Carton Weight lb (kg)	UPC
G07X18450DNL14 ①	7 (2.13)	18 (0.46)	525	480	1	5.1 (2.3)	01362718477
G07X18750D	7 (2.13)	18 (0.46)	525	277	1	5.1 (2.3)	01362718461
G07X18750DNL14 ①	7 (2.13)	18 (0.46)	525	277	1	5.1 (2.3)	01362718417
G07X18850D	7 (2.13)	18 (0.46)	525	208	1	4.6 (2.1)	01362718402
G07X18850DNL14 ①	7 (2.13)	18 (0.46)	525	208	1	4.6 (2.1)	01362718498
G08X18250D	8 (2.44)	18 (0.46)	600	240	1	5.2 (2.4)	01362718379
G08X18250DNL14 ①	8 (2.44)	18 (0.46)	600	240	1	5.2 (2.4)	01362718441
G08X18450D	8 (2.44)	18 (0.46)	600	480	1	5.1 (2.3)	01362718511
G08X18450DNL14 ①	8 (2.44)	18 (0.46)	600	480	1	5.1 (2.3)	01362718478
G08X18750D	8 (2.44)	18 (0.46)	600	277	1	5.1 (2.3)	01362718439
G08X18750DNL14 ①	8 (2.44)	18 (0.46)	600	277	1	5.1 (2.3)	01362718418
G08X18850D	8 (2.44)	18 (0.46)	600	208	1	5.2 (2.4)	01362718398
G09X18250DNL14 ①	9 (2.74)	18 (0.46)	675	240	1	5.2 (2.4)	01362718442
G09X18450D	9 (2.74)	18 (0.46)	675	480	1	5.5 (2.5)	01362718512
G09X18450DNL14 ①	9 (2.74)	18 (0.46)	675	480	1	5.5 (2.5)	01362718479
G09X18750D	9 (2.74)	18 (0.46)	675	277	1	5.5 (2.5)	01362718462
G09X18450DNL14 ①	9 (2.74)	18 (0.46)	675	480	1	5.5 (2.5)	01362718479
G09X18750D	9 (2.74)	18 (0.46)	675	277	1	5.5 (2.5)	01362718462
G09X18750DNL14 ①	9 (2.74)	18 (0.46)	675	277	1	5.5 (2.5)	01362718419
G09X18850D	9 (2.74)	18 (0.46)	675	208	1	5.5 (2.5)	01362718484
G09X18850DNL14 ①	9 (2.74)	18 (0.46)	675	208	1	5.5 (2.5)	01362718525
G10X18250D	10 (3.05)	18 (0.46)	750	240	1	6.4 (2.9)	01362718399
G10X18250DNL14 ①	10 (3.05)	18 (0.46)	750	240	1	6.4 (2.9)	01362718444
G10X18450D	10 (3.05)	18 (0.46)	750	480	1	5.7 (2.6)	01362718513
G10X18450DNL14 ①	10 (3.05)	18 (0.46)	750	480	1	5.7 (2.6)	01362718415
G10X18750D	10 (3.05)	18 (0.46)	750	277	1	6.2 (2.8)	01362718463
G10X18750DNL14 ①	10 (3.05)	18 (0.46)	750	277	1	6.2 (2.8)	01362718420
G10X18850D	10 (3.05)	18 (0.46)	750	208	1	6.6 (3.0)	01362718485
G10X18850DNL14 ①	10 (3.05)	18 (0.46)	750	208	1	6.6 (3.0)	01362718473
G10X36250D	10 (3.05)	36 (0.91)	1500	240	1	9.7 (4.4)	01362718408
G10X36250DNL14 ①	10 (3.05)	36 (0.91)	1500	240	1	9.7 (4.4)	01362718451
G10X36450D	10 (3.05)	36 (0.91)	1500	480	1	9.7 (4.4)	01362718519
G10X36450DNL14 ①	10 (3.05)	36 (0.91)	1500	480	1	9.7 (4.4)	01362718471
G10X36750D	10 (3.05)	36 (0.91)	1500	277	1	9.7 (4.4)	01362718456
G10X36750DNL14 ①	10 (3.05)	36 (0.91)	1500	277	1	9.7 (4.4)	01362718424

① Other cold lead lengths available; To order, add "NL" to the part number, then specify desired length in feet and inches.

EasyHeat™ Sno* Melter™ Mats

Snow Melting, Constant Wattage, Hard-wired. For Residential and Commercial Applications.

Standard Sno* Melter Mats Product Selection

Catalog Number	Mat Length ft (m)	Mat Width in (m)	Power Watts	Vac	Carton Quantity	Carton Weight lb (kg)	UPC
G10X36850D	10 (3.05)	36 (0.91)	1500	208	1	9.7 (4.4)	01362718490
G10X36850DNL14 ①	10 (3.05)	36 (0.91)	1500	208	1	9.7 (4.4)	01362718503
G15X18250D	15 (4.57)	18 (0.46)	1125	240	1	7.7 (3.5)	01362718400
G15X18250DNL14 ①	15 (4.57)	18 (0.46)	1125	240	1	7.7 (3.5)	01362718445
G15X18450D	15 (4.57)	18 (0.46)	1125	480	1	9.7 (4.4)	01362718514
G15X18450DNL14 ①	15 (4.57)	18 (0.46)	1125	480	1	9.7 (4.4)	01362718480
G15X18750D	15 (4.57)	18 (0.46)	1125	277	1	9.7 (4.4)	01362718464
G15X18750DNL14 ①	15 (4.57)	18 (0.46)	1125	277	1	9.7 (4.4)	01362718403
G15X18850D	15 (4.57)	18 (0.46)	1125	208	1	9.7 (4.4)	01362718486
G15X18850DNL14 ①	15 (4.57)	18 (0.46)	1125	208	1	9.7 (4.4)	01362718500
G15X36250D	15 (4.57)	36 (0.91)	2250	240	1	13.2 (6.0)	01362718411
G15X36250DNL14 ①	15 (4.57)	36 (0.91)	2250	240	1	13.2 (6.0)	01362718452
G15X36450D	15 (4.57)	36 (0.91)	2250	480	1	13.2 (6.0)	01362718520
G15X36450DNL14 ①	15 (4.57)	36 (0.91)	2250	480	1	13.2 (6.0)	01362718472
G15X36750D	15 (4.57)	36 (0.91)	2250	277	1	13.2 (6.0)	01362718457
G15X36750DNL14 ①	15 (4.57)	36 (0.91)	2250	277	1	13.2 (6.0)	01362718429
G15X36850D	15 (4.57)	36 (0.91)	2250	208	1	13.4 (6.1)	01362718493
G15X36850DNL14 ①	15 (4.57)	36 (0.91)	2250	208	1	13.4 (6.1)	01362718504
G20X18250D	20 (6.10)	18 (0.46)	1500	240	1	9.5 (4.3)	01362718401
G20X18250DNL14 ①	20 (6.10)	18 (0.46)	1500	240	1	9.5 (4.3)	01362718446
G20X18450D	20 (6.10)	18 (0.46)	1500	480	1	9.5 (4.3)	01362718515
G20X18450DNL14 ①	20 (6.10)	18 (0.46)	1500	480	1	9.5 (4.3)	01362718481
G20X18750D	20 (6.10)	18 (0.46)	1500	277	1	9.7 (4.4)	01362718467
G20X18750DNL14 ①	20 (6.10)	18 (0.46)	1500	277	1	9.7 (4.4)	01362718422
G20X18850D	20 (6.10)	18 (0.46)	1500	208	1	9.5 (4.3)	01362718487
G20X18850DNL14 ①	20 (6.10)	18 (0.46)	1500	208	1	9.5 (4.3)	01362718443
G20X36250D	20 (6.10)	36 (0.91)	3000	240	1	17.2 (7.8)	01362718412
G20X36250DNL14 ①	20 (6.10)	36 (0.91)	3000	240	1	17.2 (7.8)	01362718453
G20X36450D	20 (6.10)	36 (0.91)	3000	480	1	17.0 (7.7)	01362718521
G20X36450DNL14 ①	20 (6.10)	36 (0.91)	3000	480	1	17.0 (7.7)	01362718474
G20X36750D	20 (6.10)	36 (0.91)	3000	277	1	16.8 (7.6)	01362718458
G20X36750DNL14 ①	20 (6.10)	36 (0.91)	3000	277	1	16.8 (7.6)	01362718426
G20X36850D	20 (6.10)	36 (0.91)	3000	208	1	17.0 (7.7)	01362718494
G20X36850DNL10 ①	20 (6.10)	36 (0.91)	3000	208	1	17.0 (7.7)	01362718505
G30X18250D	30 (9.14)	18 (0.46)	2250	240	1	12.8 (5.8)	01362718406

① Other cold lead lengths available; To order, add "NL" to the part number, then specify desired length in feet and inches.

EasyHeat™ Sno* Melter™ Mats

Snow Melting, Constant Wattage, Hard-wired. For Residential and Commercial Applications.

Standard Sno* Melter Mats Product Selection

Catalog Number	Mat Length ft (m)	Mat Width in (m)	Power Watts	Vac	Carton Quantity	Carton Weight lb (kg)	UPC
G30X18250DNL14 ①	30 (9.14)	18 (0.46)	2250	240	1	12.8 (5.8)	01362718447
G30X18450D	30 (9.14)	18 (0.46)	2250	480	1	13.2 (6.0)	01362718516
G30X18450DNL14 ①	30 (9.14)	18 (0.46)	2250	480	1	13.2 (6.0)	01362718482
G30X18750D	30 (9.14)	18 (0.46)	2250	277	1	13.0 (5.9)	01362718468
G30X18750DNL14 ①	30 (9.14)	18 (0.46)	2250	277	1	13.0 (5.9)	01362718427
G30X18850D	30 (9.14)	18 (0.46)	2250	208	1	13.2 (6.0)	01362718488
G30X18850DNL14 ①	30 (9.14)	18 (0.46)	2250	208	1	13.2 (6.0)	01362718501
G30X36250D	30 (9.14)	36 (0.91)	4500	240	1	15.9 (7.2)	01362718413
G30X36250DNL10 ①	30 (9.14)	36 (0.91)	4500	240	1	15.9 (7.2)	01362718454
G30X36450D	30 (9.14)	36 (0.91)	4500	480	1	24.0 (10.9)	01362718522
G30X36450DNL14 ①	30 (9.14)	36 (0.91)	4500	480	1	24.0 (10.9)	01362718475
G30X36750D	30 (9.14)	36 (0.91)	4500	277	1	28.2 (12.8)	01362718459
G30X36750DNL10 ①	30 (9.14)	36 (0.91)	4500	277	1	28.2 (12.8)	01362718423
G30X36850D	30 (9.14)	36 (0.91)	4500	208	1	29.3 (13.3)	01362718495
G30X36850DNL10 ①	30 (9.14)	36 (0.91)	4500	208	1	29.3 (13.3)	01362718506

① Note: Other cold lead lengths available; To order, add "NL" to the part number, then specify desired length in feet and inches.

Custom Sno* Melter Mats

Selection of custom snow mats is accomplished by determining the size of the area to be heated and the voltage available. This is achieved by doing the following:

1. Determine size of mats, allowing for expansion and construction joints, obstructions, etc.
2. Assign a part number for all mats as shown below.
3. Orders for modified mats must include scale drawings showing exact shape, size and point where leads exit.
4. For ordering assistance contact your local EasyHeat sales representative.

Custom Sno* Melter Mats Catalog Number Guide

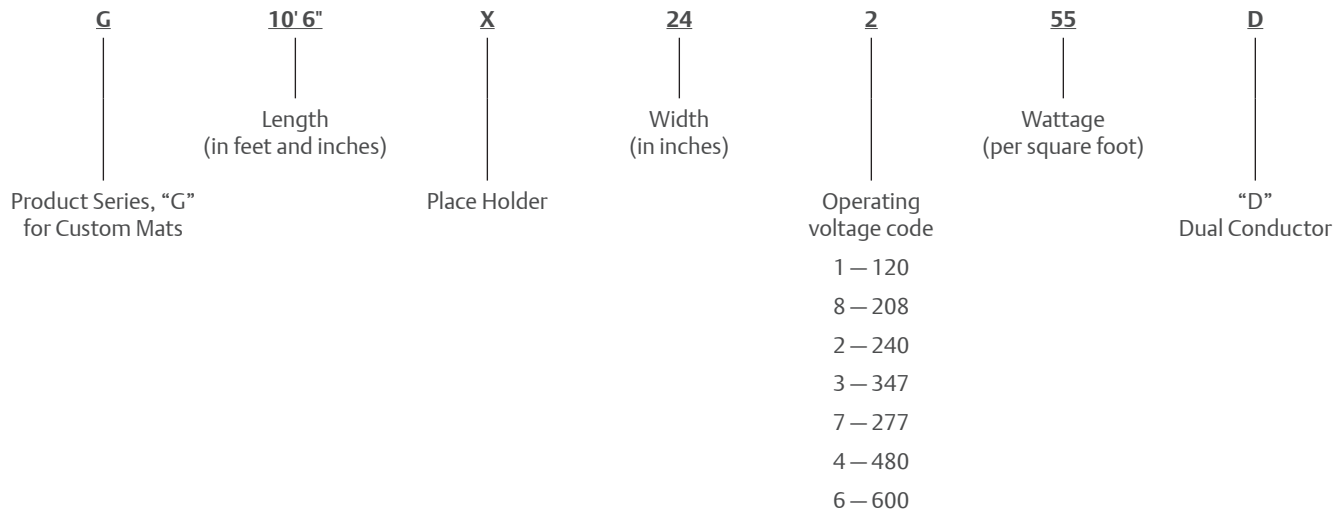

Note: Other cold lead lengths available; To order, add "NL" to the part number, then specify desired length in feet and inches. Contact a local EasyHeat™ sales representative for assistance.

EasyHeat™ Sno* Melder™ Mats

Snow Melting, Constant Wattage, Hard-wired. For Residential and Commercial Applications.

Step Sno* Melder™ Mats

Step mats can be used independently or in conjunction with standard or custom mats to keep stairs free of snow and ice. These mats are available in 2 or 3 step models. Custom step mats are available for nonstandard power densities. Please contact EasyHeat™ representative for details.



Step Snow Mats Product Selection

Catalog Number	Description	# of Steps	Width ft (m)	Depth in (m)	Watts	Amps	Vac	Ctn Qty	UPC
2M230X850D	2 step, 3 ft x 8 in (0.91 m x 0.20 m), 240 Vac	2	3 (0.91)	8 (0.20)	200	0.8	240	1	01362718536
2M230X850DNL14 ①	2 step, 3 ft x 8 in (0.91 m x 0.20 m), 240 Vac	2	3 (0.91)	8 (0.20)	200	0.8	240	1	01362718535
2M260X850D	2 step, 6 ft x 8 in (1.83 m x 0.20 m), 240 Vac	2	6 (1.83)	8 (0.20)	400	1.7	240	1	01362718538
2M260X850DNL14 ①	2 step, 6 ft x 8 in (1.83 m x 0.20 m), 240 Vac	2	6 (1.83)	8 (0.20)	400	1.7	240	1	01362718537
2M460X850D	2 step, 6 ft x 8 in (1.83 m x 0.20 m), 480 Vac	2	6 (1.83)	8 (0.20)	400	0.8	480	1	01362718556
2M460X850DNL14 ①	2 step, 6 ft x 8 in (1.83 m x 0.20 m), 480 Vac	2	6 (1.83)	8 (0.20)	400	0.8	480	1	01362718555
2M730X850D	2 step, 3 ft x 8 in (0.91 m x 0.20 m), 277 Vac	2	3 (0.91)	8 (0.20)	200	0.7	277	1	01362718548
2M730X850DNL14 ①	2 step, 3 ft x 8 in (0.91 m x 0.20 m), 277 Vac	2	3 (0.91)	8 (0.20)	200	0.7	277	1	01362718546
2M760X850D	2 step, 6 ft x 8 in (1.83 m x 0.20 m), 277 Vac	2	6 (1.83)	8 (0.20)	400	1.4	277	1	01362718550
2M760X850DNL14 ①	2 step, 6 ft x 8 in (1.83 m x 0.20 m), 277 Vac	2	6 (1.83)	8 (0.20)	400	1.4	277	1	01362718549
2M830X850D	2 step, 3 ft x 8 in (0.91 m x 0.20 m), 208 Vac	2	3 (0.91)	8 (0.20)	200	1	208	1	01362718527
2M830X850DNL14 ①	2 step, 3 ft x 8 in (0.91 m x 0.20 m), 208 Vac	2	3 (0.91)	8 (0.20)	200	1	208	1	01362718526
2M860X850D	2 step, 6 ft x 8 in (1.83 m x 0.20 m), 208 Vac	2	6 (1.83)	8 (0.20)	400	1.9	208	1	01362718529
2M860X850DNL14 ①	2 step, 6 ft x 8 in (1.83 m x 0.20 m), 208 Vac	2	6 (1.83)	8 (0.20)	400	1.9	208	1	01362718528
3M230X850D	3 step, 3 ft x 8 in (0.91 m x 0.20 m), 240 Vac	3	3 (0.91)	8 (0.20)	300	1.3	240	1	01362718540
3M230X850DNL14 ①	3 step, 3 ft x 8 in (0.91 m x 0.20 m), 240 Vac	3	3 (0.91)	8 (0.20)	600	1.3	240	1	01362718539
3M260X850D	3 step, 6 ft x 8 in (1.83 m x 0.20 m), 240 Vac	3	6 (1.83)	8 (0.20)	600	2.5	240	1	01362718542
3M260X850DNL14 ①	3 step, 6 ft x 8 in (1.83 m x 0.20 m), 240 Vac	3	3 (0.91)	8 (0.20)	300	2.5	240	1	01362718541
3M430X850D	3 step, 3 ft x 8 in (0.91 m x 0.20 m), 480 Vac	3	3 (0.91)	8 (0.20)	300	0.6	480	1	01362718559
3M430X850DNL14 ①	3 step, 3 ft x 8 in (0.91 m x 0.20 m), 480 Vac	3	3 (0.91)	8 (0.20)	600	0.6	480	1	01362718557
3M460X850D	3 step, 6 ft x 8 in (1.83 m x 0.20 m), 480 Vac	3	6 (1.83)	8 (0.20)	600	1.3	480	1	01362718531
3M460X850DNL14 ①	3 step, 6 ft x 8 in (1.83 m x 0.20 m), 480 Vac	3	6 (1.83)	8 (0.20)	300	1.3	480	1	01362718547
3M730X850D	3 step, 3 ft x 8 in (0.91 m x 0.20 m), 277 Vac	3	3 (0.91)	8 (0.20)	300	1.1	277	1	01362718552
3M730X850DNL14 ①	3 step, 3 ft x 8 in (0.91 m x 0.20 m), 277 Vac	3	6 (1.83)	8 (0.20)	600	1.1	277	1	01362718551
3M760X850D	3 step, 6 ft x 8 in (1.83 m x 0.20 m), 277 Vac	3	6 (1.83)	8 (0.20)	600	2.2	277	1	01362718554
3M760X850DNL14 ①	3 step, 6 ft x 8 in (1.83 m x 0.20 m), 277 Vac	3	3 (0.91)	8 (0.20)	300	2.2	277	1	01362718553
3M830X850D	3 step, 3 ft x 8 in (0.91 m x 0.20 m), 208 Vac	3	3 (0.91)	8 (0.20)	300	1.4	208	1	01362718532
3M830X850DNL14 ①	3 step, 3 ft x 8 in (0.91 m x 0.20 m), 208 Vac	3	3 (0.91)	8 (0.20)	600	1.4	208	1	01362718530
3M860X850D	3 step, 6 ft x 8 in (1.83 m x 0.20 m), 208 Vac	3	6 (1.83)	8 (0.20)	600	2.9	208	1	01362718534
3M860X850DNL14 ①	3 step, 6 ft x 8 in (1.83 m x 0.20 m), 208 Vac	3	6 (1.83)	8 (0.20)	300	2.9	208	1	01362718533

① No lead, contact your local EasyHeat™ representative to order a separate cold lead length.

EasyHeat™ SMK Cable Kits

Snow Melting, Constant Wattage, Hard-wired. For Residential and Commercial Applications.

Product Overview

- SMK Cable Kits are comprised of a single heating cable, designed to cover unique walkway, stair, patio, and driveway configurations to melt snow and ice off of concrete and pavers.

Applications

- Prevention of snow and ice accumulation on steps, walkways, driveways, parking areas, loading docks and roads.

Features

- Available in sizes that cover 10 ft² – 100 ft² (0.93 m² – 9.3 m²) using a single cable.
- Dual-element, fixed-resistance cables are sized by area to fit varied layout requirements.
- Suitable for use in 208 Vac or 240 Vac applications depending on cable spacing configurations.
- Standard cold lead length is 20 ft (6.10 m).
- One year limited warranty.

Related Products

- It is recommended that SMK Cable Kits be controlled by the SA1 Controller to provide economical, automatic, prevention of snow and ice accumulation. See *EasyHeat Snow Melting Controls*.

Accessories

- EasyHeat offers a variety accessories that can be used with SMK Cable Kits. See *EasyHeat Snow Melting Accessories*.

Certifications

- UL Listed and CSA Certified.



Notes

- Per NEC and CEC requirements ALWAYS use a ground fault protection device (GFEP) to reduce the danger of fire from a damaged or improperly installed heating cable. Electrical fault currents caused by damaged or improperly installed cable MAY NOT BE LARGE ENOUGH to trip a conventional circuit breaker.
- Heating cables must be installed in compliance with all national, state/provincial and local codes. Check with your local electrical inspector for specific details.
- Do not alter the length of the heating cable.
- Never allow the heating cables to touch, cross or overlap each other at any point.
- Do not allow cables to kink or twist while installing.
- SMK Cable Kits must be secured to welded wire mesh or rebar.
- Minimum installation temperature is +32 °F (0 °C).
- SMK Cable Kits cannot be installed in asphalt.

Voltage/Power

Voltage	Cable Spacing in. (mm)	Watts/ft ²
240	3 (75)	45
	4 (100)	35
	5 (125)	27
	6 (150)	22
208	2 (50)	45
	3 (75)	35
	4 (100)	22
	5 (125)	15

Product Selection

Catalog Number	Area Coverage ft ² (m ²)	Total Watts	Amp	Cold Lead	Carton Quantity	Carton Weight lb (kg)	UPC
SMK00102	10 (0.93)	450	1.9	14 AWG	1	5.2 (2.4)	01362717096
SMK00152	15 (1.39)	719	3.0	14 AWG	1	6.2 (2.8)	01362717097
SMK00202	20 (1.86)	921	3.8	14 AWG	1	7.2 (3.3)	01362717098
SMK00252	25 (2.32)	1157	4.8	14 AWG	1	8.1 (3.7)	01362717099
SMK00302	30 (2.79)	1350	5.6	14 AWG	1	9.0 (4.1)	01362717101
SMK00402	40 (3.72)	1848	7.7	14 AWG	1	11.0 (5.0)	01362717102
SMK00502	50 (4.64)	2209	9.2	14 AWG	1	12.9 (5.9)	01362717103
SMK00602	60 (5.57)	2778	11.6	14 AWG	1	15.3 (6.9)	01362717104
SMK00702	70 (6.50)	3214	13.4	14 AWG	1	16.1 (7.3)	01362717105
SMK00802	80 (7.43)	3689	15.4	10 AWG	1	19.9 (9.0)	01362717106
SMK00902	90 (8.36)	4255	17.7	10 AWG	1	21.6 (9.8)	01362717107
SMK01002	100 (9.29)	4557	19.0	10 AWG	1	23.6 (10.7)	01362717108

EasyHeat™ MI Trace Cable

Constant Wattage. For Commercial Applications.

Product Overview

- MI Trace cable is a high performance, fixed resistance, industrial grade heating cable. The Alloy 825 sheath is ideally suited for use in areas where higher temperatures and/or power outputs are required, a more rugged cable construction is needed, or required supply voltage exceeds 300 Vac.
- MI Trace cables replace less efficient means of snow removal such as heated water or oil circulating systems, plowing or shoveling and offer an effective alternative to the application of salts and other chemicals which result in pavement damage.

Applications

- The prevention of snow and ice accumulation in commercial applications.

Features

- Available in custom engineered lengths for 120, 208, 240, 277, 347, 480, and 600 Vac applications.
- Outer sheath construction is Alloy 825, a high temperature corrosion resistant alloy with superior flexibility.
- Available in single conductor (SMI) or dual conductor (DMI) construction.
- One year limited warranty.

Ordering Information

- We can assist you to select the appropriate heating cable for your application. Contact your local EasyHeat™ representative for details.

Related Products

- It is recommended that a snow melting controller be used to provide reliable, automatic and economical operation of embedded snow melting systems. See *EasyHeat™ Snow Melting Controls*. Control options available:
 - MSC1 Controller (*Sensors, purchased separately, are required for the MSC1*)
 - SA1 Controller



Certifications

- UL Listed, CSA Certified, and Factory Mutual Approved for ordinary and hazardous locations.

Note:

- Per NEC and CEC requirements ALWAYS use a ground fault protection device (GFEP) to reduce the danger of fire from a damaged or improperly installed heating cable. Electrical fault currents caused by damaged or improperly installed cable MAY NOT BE LARGE ENOUGH to trip a conventional circuit breaker.
- Install cable so minimal re-bending is required to service equipment. Cable will work harden and break if repeatedly re-bent.
- Do not bend the heating cable within 3 in (76.2 mm) of fittings. Fitting joints could be damaged.
- Do not bend the heating cable to an inside radius of less than five times the cable's diameter. This will damage the cable.

Illustrated Features

The MI Trace cable is a metal sheathed cable that uses metallic conductors as the heating elements. The conductors are electrically insulated from the metal sheath by mineral-magnesium oxide (MgO). The mineral insulated cable is a series resistance heater that generates heat when electrical current passes through the heating elements.

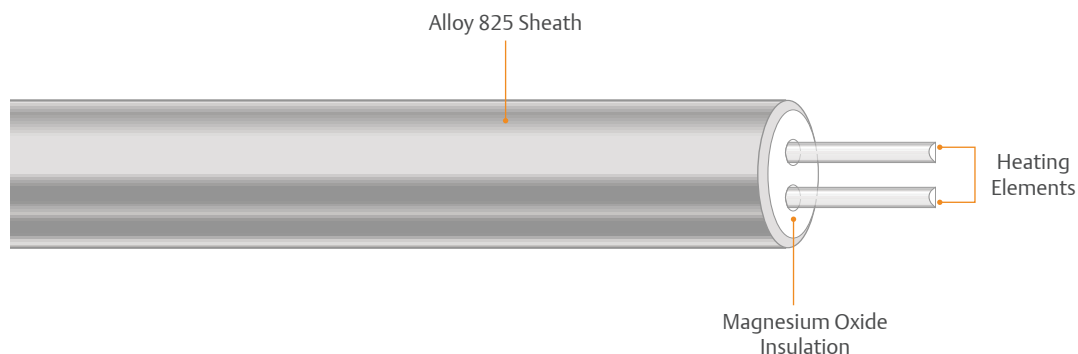

EasyHeat™ Snow Melting Controls

Snow Melting. For Commercial Applications.

Product Overview

- EasyHeat™ snow melting controls are designed and manufactured for use of controlling snow melting cables and mats.

SA1 Automatic Snow/Ice Melting Controller

- Uses microcontroller technology to energize the heating cable only when specific conditions of temperature and moisture exist.
- LED indicator indicates when system is operating, and also when sensor needs to be cleaned.
- Voltage: 120 Vac
- Current: 16 Amps
- Operating temperature: -40 °F to +150 °F (-40 °C to +65 °C)
- Storage temperature: -49 °F to +160 °F (-45 °C to +70 °C)
- One year limited warranty.

MSC1 Controller

- Commercial grade unit suitable for controlling snow and ice melting off sidewalks, and driveways.
- MSC1 control panel is capable of monitoring snow/ice accumulation in three separate snow melting application zones and issuing separate control signals for each zone.
- NEMA 4, 4X enclosure for commercial/industrial indoor applications.
- LCD display, programming and associated indicator lights, confirming the operation of each zone.
- Includes TS1 temperature sensor.
- Voltage: 120 Vac
- Operating temperature: -4 °F to +160 °F (-20 °C to +70 °C)
- Storage temperature: -4 °F to +185 °F (-20 °C to +85 °C)
- One year limited warranty.

MSA1 Aerial Moisture Sensor

- Must be used in conjunction with the MSC1 Controller.
- Detects falling or blowing snow coming in contact with the sensor grid, then sends a signal to the MSC1 to energize heating equipment.
- Supplied with connection wire that can be extended up to 500 ft (152 m) with an appropriately rated 18-20 AWG 3 wire unshielded stranded cable.
- Voltage: 24 Vac
- Current: 500 mA
- Operating and storage temperature: -40 °F to +160 °F (-40 °C to +70 °C)
- One year limited warranty.



SA1 Automatic Snow/Ice Melting Controller



MSC1 Controller



MSA1 Aerial Moisture Sensor

EasyHeat™ Snow Melting Controls

Snow Melting. For Commercial Applications.

MSP1 Sensor

- Must be used in conjunction with the MSC1 Controller.
- Encased within a rugged enclosure and is designed to be embedded in the surface.
- Comes with 30 ft (9 m) of wire for connection back to the MSC1 control unit.
- Embedded pavement sensor monitors slab temperature to ensure optimum energy savings.
- Supplied with a protective field cover to simplify asphalt or concrete installations.
- Voltage: 24 Vac
- Current: 500 mA
- Operating temperature: -40 °F to +160 °F (-40 °C to +70 °C)
- Storage temperature: -40 °F to +160 °F (-40 °C to +70 °C)
- One year limited warranty.

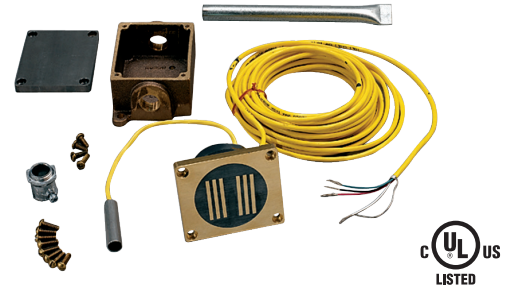

MSP1 Sensor

TS1 Temperature Sensor

- Replacement TS1 temperature sensor.
- Measures ambient temperatures.
- Supplied with 10 ft (3 m) of connection wire which can be extended up to 500 ft (152 m) with an appropriately rated 18-20 AWG 3 wire unshielded stranded cable.
- Voltage: 120 Vac
- Current: 16 mA
- Operating temperature: -40 °F to +150 °F (-40 °C to +65 °C)
- Storage temperature: -49 °F to +160 °F (-45 °C to +70 °C)
- One year limited warranty.



TS1 Temperature Sensor

PC Series Magnetic Power Contactors

- Resistance rated and may be utilized to switch or interrupt high voltage and/or high current loads with low voltage control devices.
- Contactors are supplied in a NEMA type 1 general purpose enclosure.
- One year limited warranty.



PC Series Magnetic Power Contactors

Certifications

- The following controllers are UL Listed to US and Canadian Safety Standards:
 - MSC1
 - MSP1
 - MSA1
 - MSG1
 - SA1
 - TS1
 - MSCA1
 - MSCP1
- All PC Series units are CSA Certified and UL recognized and are complete with a NEMA 1 enclosure.

SNOW MELTING

EasyHeat™ Snow Melting Controls

Snow Melting. For Commercial Applications.

Product Selection

Catalog Number	Description	Carton Quantity	Carton Weight lb (kg)	UPC
MSC1	Controller (with TS1)	1	8.5 (3.9)	01362701500
MSA1	Aerial sensor	1	2.0 (0.9)	01362701501
MSP1	In-ground sensor	1	6.5 (2.9)	01362701503
SA1	Small system automatic control	1	1.5 (0.7)	01362709935
TS1	Replacement temperature sensor	1	1.5 (0.7)	01362701504
MSCA1 ①	Controller, TS1, MSA1	1	11.0 (5.0)	01362701505
MSCP1 ①	Controller, TS1, MSP1	1	11.0 (5.0)	01362701506
PC403F	Magnetic power contactor, 40 Amps, 120 Vac	1	4.4 (2.0)	01362709828
PC403G	Magnetic power contactor, 40 Amps, 240 Vac	1	4.4 (2.0)	01362709829
PC503F	Magnetic power contactor, 50 Amps, 120 Vac	1	4.4 (2.0)	01362709831
PC503G	Magnetic power contactor, 50 Amps, 240 Vac	1	4.4 (2.0)	01362709832
PC603F	Magnetic power contactor, 62 Amps, 120 Vac	1	4.8 (2.2)	01362709837
PC603G	Magnetic power contactor, 62 Amps, 240 Vac	1	4.8 (2.2)	01362709838
PC753F	Magnetic power contactor, 75 Amps, 120 Vac	1	4.8 (2.2)	01362709844
PC753G	Magnetic power contactor, 75 Amps, 240 Vac	1	4.8 (2.2)	01362709845
PC933F	Magnetic power contactor, 94 Amps, 120 Vac	1	13.2 (5.9)	01362709852
PC933G	Magnetic power contactor, 94 Amps, 240 Vac	1	13.2 (5.9)	01362709853
PC1123F	Magnetic power contactor, 120 Amps, 120 Vac	1	13.2 (5.9)	01362709855
PC1123G	Magnetic power contactor, 120 Amps, 240 Vac	1	13.2 (5.9)	01362709856

SNOW MELTING

① System package for MSC.

EasyHeat™ Snow Melting Controls

Snow Melting. For Commercial Applications. Available Exclusively for Canada.

Product Overview

- Our EasyHeat™ snow melting controls, available exclusively for Canada, are designed and manufactured for use of controlling snow melting cables and mats.

SMC54WP Thermostat

- Available exclusively for Canada.
- One control for heating and cooling.
- Rugged, weather-resistant enclosure.
- Performs despite water spray, high humidity, airborne contaminants and moderately corrosive conditions.
- Large, visible dial to make set point temperatures clear.
- Reliable SPDT switch.
- Voltage: 120, 208, 240 or 277 Vac
- Current: 8 Amps
- Operating temperature: -30 °F to +100 °F (-34 °C to +38 °C)
- One year limited warranty.



SMC54WP Thermostat



SMC51/SMC52 Thermostat



SMC51/SMC52 Thermostat

- Available exclusively for Canada.
- Universal mounting bracket is available for easy replacement.
- Control setpoint is dial-knob adjustable.
- Models are available with fixed or adjustable temperature differentials.
- Reliable SPDT switch.
- Ambient temperature compensated.
- Voltage: 120 or 240 Vac
- Current: 8 Amps
- Operating temperature: -30 °F to +90 °F (-34 °C to +32 °C)
- One year limited warranty.

Certifications

- SMC51, SMC52 and SMC54WP thermostats are UL and CSA Certified.

Product Selection

Catalog Number	Description	Carton Quantity	Carton Weight lb (kg)	UPC
SMC51	Indoor thermostat with 8 ft (2.40 m) capillary	1	2.0 (0.9)	01362700129
SMC52	Indoor thermostat with 20 ft (6.10 m) capillary	1	2.0 (0.9)	01362700214
SMC54WP	Weatherproof thermostat	1	2.0 (0.9)	01362716918

EasyHeat™ Snow Melting Accessories

For Commercial and Residential Applications

Product Overview

- We provide the right hardware for helping to install our snow melting systems.

SKDG Splice kit

- The SKDG splice kit is used to repair damaged dual and single conductor EasyHeat™ snow melting mats and cable kits.
- One year limited warranty.

NMPLT Snow Melting Nameplate

- The NMPLT Nameplate is a NEC requirement for all snow melting installations.
- Material: Brass
- Dimension: 3.75 in x 6.25 in (95.25 mm x 158.75 mm)
- One year limited warranty.

Detecto DT1 Heating Cable and Mat Fault Indicator

- The Detecto DT1 heating cable and mat fault indicator (battery operated) is designed to monitor EasyHeat™ cable or mat systems at every step during installation.
- Detecto DT1 sounds an alarm immediately in the event of circuit interruption or ground fault detected in the cable.
- One year limited warranty.

Cold Lead Extension Cables

- Additional 14CL (14 AWG conductor) and 10CL (10 AWG conductor) are available only for extending cold leads on EasyHeat™ snow melting cables.
- Cold leads longer than standard lengths are sold either factory spliced onto mats or cut-to-order on separate reels.
 - Factory spliced leads are available in 1 ft (0.03 m) increments.
 - Cut-to-order leads are sold by the foot.
 - #14 AWG to 14 Amps, #10 AWG to 30 Amps.
- One year limited warranty.

Certifications

- Cold lead extension cables are UL Listed and CSA Certified.
- Detecto DT1 conforms to European Directives.

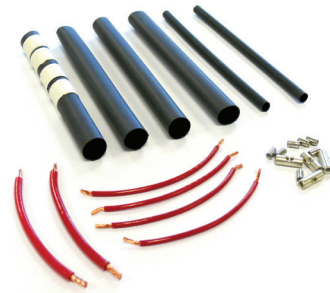

SKDG Splice kit



NMPLT Nameplate



Detecto DT1 Heating Cable and Mat Fault Indicator

Product Selection

Catalog Number	Description	Carton Quantity	Carton Weight lb (kg)	UPC
14DCL	#14 AWG Cold Lead, Price/ft. - Cut-to-order on separate reel	1	0.057 (0.025) per foot	01362718971
10DCL	#10 AWG Cold Lead, Price/ft. - Cut-to-order on separate reel	1	0.057 (0.025) per foot	01362718970
SKDG	Splice kit - makes 3 splices	1	1 (0.5)	01362707041
NMPLT	Sno* Melter™ nameplate (For NEC 426-13 compliance)	1	3 (1.4)	01362707046
DT1	Detecto heating cable and mat fault indicator	5	1 (0.5)	01362701296



In-Line Heating

Many cottages, barns and homes draw water from a local water source, using polyethylene pipes that can freeze during the winter. Emerson offers EasyHeat™ in-line solutions as economical alternatives that protect supply and drain pipes and maintain running water all winter long.

EasyHeat™ In-Line Heating Selection Guide

Criteria	ILH	ILSR using TSR31F	ILSR using SR31J
1. What is the target application?			
Potable Water	✓	✓	–
Non-Potable Water	–	✓	✓
Drain Line	–	✓	✓
2. What is the diameter of the pipe?			
Pipe Diameter	1-1/4 in	3/4 in – 2 in (single cable) 2 in – 6 in (two cables)	3/4 in – 2 in (single cable) 2 in – 6 in (two cables)
3. What is the material of the pipe?			
Plastic (PEX, PVC, Polybutelene, etc.)	✓ ^①	✓	✓
Metal (Copper, Steel, etc.)	–	✓	✓
4. Where is the location of the pipe?			
Above Ground	✓	✓	✓
Below Ground	✓	✓	✓
Indoor/Dry Location	✓	✓	✓
5. What is the power rating?			
Power Rating	Constant: 5 Watts/ft	Self-regulating: 3 Watts/ft @ +50 °F (+10 °C)	Self-regulating: 3 Watts/ft @ +50 °F (+10 °C)
6. What is the available supply voltage?			
Supply Voltage (Vac)	120	120	120
Power Cord	6 ft (1.83 m)	3.5 ft (1.07 m)	3.5 ft (1.07 m)
7. How much length of heating cable is needed?			
Cable Lengths	10 ft – 270 ft (3 m - 82.3 m)	Cut-to-length ^①	Cut-to-length ^①

✓ Applicable
 – Not Applicable
 ① Verify with your local EasyHeat sales representative.

EasyHeat™ In-Line Heater

In-Line Heating, Inside-the-Pipe Potable Water Heating Cable. For Residential Applications.

Product Overview

- The In-Line Heater (ILH) provides economical, effective in-pipe freeze protection for water supply lines.
- It can be used in insulated pipes and will not melt through the pipe if dryout occurs.

Applications

- Preventing freezing of water supply in cottages, homes and barns that use a lake, reservoir or spring for their potable water.

Features

- Designed for use in 1.25 in (3.18 cm) polyethylene water pipes.
- Includes a 12 Amp energy saving thermostat complete with ground fault circuit interrupter (GFCI) receptacle.
- Protected by GFCI with test/reset and pilot light to ensure safe operation.
- Dual conductor resistance wire with PVC insulation, continuous ground braid, and clear food-grade outer PVC jacket.
- Rated to withstand water pressure up to 60 PSIG.
- Available in lengths from 10 ft – 270 ft (3.05 m – 82.30 m).
- User friendly plug-in 120 Vac operation (5 W/ft).
- One year limited warranty.

Related Products

- The SL2G thermostat provides automatic temperature control to conserve energy and extend cable life. See EasyHeat™ SL Thermostatic Controllers.

Certifications

- CSA Certified.



In-Line Heater (ILH)



SL2G Thermostat



Notes

- Do not attempt to pull the cable by the end connector; this connector prevents the infiltration of water into the cable, and excessive force could damage this seal.
- The heating cable cannot be altered in length.
- Never plug in the heating cable while it is coiled. If the heating cable touches itself while plugged in this would cause the outer PVC jacket to melt.
- Do not install heating cable in pipes that are heated to above +155 °F (+66 °C).
- The cable has been pre-assembled and sealed to the T-coupling; do not alter the T-coupling connection.
- The heating cable must be installed straight inside the pipe and must not touch, cross, or overlap itself at any point inside the water pipe.
- Insulation of the piping is best accomplished by the use of a maximum of 1/2 in (12.7 mm) thick polyethylene foam (PEF) insulation. If uninsulated, the water supply pipe should be buried in at least 3 in (7.62 cm) of topsoil or sand.

Product Selection

Catalog Number	Description	Carton Quantity	Carton Weight lb (kg)	UPC
ILH4010	10 ft (3.05 m) length, 50 Watts	1	4.7 (2.13)	06999600302
ILH4020	20 ft (6.10 m) length, 100 Watts	1	5 (2.27)	06999600303
ILH4030	30 ft (9.14 m) length, 150 Watts	1	5.2 (2.36)	06999600304
ILH4040	40 ft (12.20 m) length, 200 Watts	1	6 (2.72)	06999600318
ILH4050	50 ft (15.24 m) length, 250 Watts	1	5.7 (2.59)	06999600305
ILH4060	60 ft (18.29 m) length, 300 Watts	1	7 (3.18)	06999600319
ILH4070	70 ft (21.34 m) length, 350 Watts	1	6.1 (2.77)	06999600306
ILH4090	90 ft (27.43 m) length, 450 Watts	1	6.6 (2.99)	06999600307
ILH4100	100 ft (30.48 m) length, 500 Watts	1	6.8 (3.08)	06999600308
ILH4120	120 ft (36.58 m) length, 600 Watts	1	7.2 (3.27)	06999600309
ILH4140	140 ft (42.67 m) length, 700 Watts	1	7.7 (3.49)	06999600310
ILH4160	160 ft (48.77 m) length, 800 Watts	1	8.2 (3.72)	06999600311
ILH4180	180 ft (54.86 m) length, 900 Watts	1	8.6 (3.90)	06999600312
ILH4200	200 ft (60.96 m) length, 1000 Watts	1	9.1 (4.13)	06999600313
ILH4225	225 ft (68.58 m) length, 1125 Watts	1	9.6 (4.35)	06999600314
ILH4250	250 ft (76.20 m) length, 1250 Watts	1	10.2 (4.63)	06999600315
ILH4270	270 ft (82.30 m) length, 1350 Watts	1	10.6 (4.81)	06999600316

Note: For spare cable end clip order part number 105600001. Contact your local EasyHeat™ for details.

EasyHeat™ In-Line Self-Regulating Heating System

In-Line Heating, Inside-the-Pipe Self-Regulating Heating System. For Residential Applications.

Product Overview

- The In-Line Self-Regulating (ILSR) heating system provides effective, economical, in-pipe freeze protection for potable and non-potable water supply, drain and vent lines.

Applications

- Prevent freezing of water supply in cottages, homes and barns that use a lake, reservoir or spring for their potable water.
- Process water
 - Drain lines
 - Vent pipes
- Sump pump lines

Features

- Maximum freeze protection for water supply pipes in ambient temperatures down to -40 °F (-40 °C).
- Freeze protection in plastic or metal pipes up to 6 in (15 cm) in diameter.
- 120 Vac operating voltage.
- For use with EasyHeat™ self-regulating heating cables SR31J and TSR31-F.
- Maximum cable length is 220 ft (67 m) using SR31, or 275 ft (84 m) using TSR31-F.
- Withstands water pressure up to 60 PSIG.
- ILSR Includes shrink tubes, crimp connectors, 3/4 in NPT fitting and 6 ft (2 m) pull cord with in-line ground fault circuit interrupter (GFCI) with reset button for safety protection.
- One year limited warranty.

Related Products

- ILSR can be used with the TSR31F self-regulating cable for potable, non-potable water supply lines and longer length applications. See *EasyHeat™ TSR Cable*.
- ILSR can be used with the SR31J self-regulating cable for process, non-potable water and sump pump line applications. See *EasyHeat™ SR Trace™ Cable*.
- The SL3 thermostatic control is recommended to conserve energy and extend cable life. See *EasyHeat™ SL Thermostatic Controllers*.



Certifications

- ILSR Connection Kit is CSA Certified for US and Canadian Standards.
- SR Trace™ cables are UL Listed to US and Canadian Standards.
- TSR cables are UL Listed, CSA Certified, and Factory Mutual Approved.
- SL3 Thermostat Controller is CSA Certified.

Notes

- The maximum system pressure must not exceed 60 PSIG.
- The pipe must be insulated using 1 in fiberglass foam or equivalent insulation. If uninsulated, the water pipe should be buried in at least 6 in (15 cm) of topsoil or sand.
- It is expected that one cable would be installed in 3/4 in to 2 in (19.05 mm to 50.8 mm) diameter pipe. For pipes greater than 2 in up to 6 in diameter, two parallel runs of cable would be necessary and each cable will require its own individual In-Line Self-regulating Heating System.

Product Selection

Catalog Number	Description	Carton Quantity	Carton Weight lb (kg)	UPC
ILSR	In-Pipe Connection Kit	1	2.2 (1)	01362719593
SR31J	Self-regulating heating cable, 3 Watts per foot, 120 Vac, cut-to-order length non-potable water and process water and sump pump lines	1	0.057 (0.026) per foot	01362701020
SR31J250	Self-regulating heating cable, 3 Watts per foot, 120 Vac, 250 ft (76.20 m) spool	1	20 (9.1)	01362706925
TSR31F	Self-regulating heating cable for potable drinking water, 3 Watts per foot, 120 Vac, cut-to-order length	1	0.051 (0.112) per foot	01362700302
SL3	Thermostat, adjustable dial from +36 °F to +77 °F (+2 °C to +25 °C)	1	2.2 (1)	01362719387

EasyHeat™ SL Thermostatic Controllers

In-Line Heating. For Residential Applications.

Product Overview

- SL thermostatic controllers are designed to control temperatures of fixed resistance and self-regulating heating cables, inserted into pipes to prevent freezing.

Features

- SL2G contains an integral ground fault circuit interrupter (GFCI).
- SL3 does not have an integral GFCI.
 - Heating cables connected to SL3 must have separate ground fault protection.
- 120 Vac operating voltage.
- Adjustable temperature dial from +36 °F to +77 °F (+2 °C to +25 °C).
- 1440 W maximum power capacity.
- 12.0 Amps maximum current.
- Two receptacles allow for two heating cables to be controlled simultaneously.
- Light on plug receptacle indicates when heating cable is energized.
- 4 ft (1.3 m) power cord with lighted 3-prong grounded plug.
- 10 ft (3 m) sensor detects the pipe temperature, sensor can be extended.
- Two rear mounting slots.
- One year limited warranty.

Certifications

- CSA Certified.

Notes

- All heating cable sets must be installed in compliance with all national, state/provincial and local codes. Check with your local electrical inspector for specific details.
- A maximum of two heating cable sets can be connected to the SL controller, however, the total maximum load must not exceed 1440 Watts (12 Amps).
- SL2G cannot be used in conjunction with the EasyHeat™ ILSR kit.
- The sensing wire must not be kinked or compressed during installation.



SL2G Thermostat
(For use with ILH cables)



SL3 Thermostat
(For use with ILSR cables)



Product Selection

Catalog Number	Description	Carton Quantity	Carton Weight lb (kg)	UPC
SL2G	GFCI thermostat control; 12 Amp, 120 Vac, +36 °F to +77 °F (+2 °C to +25 °C)	1	2.2 (1.0)	01362709931
SL-3	Thermostat, Adjustable dial from +36 °F to +77 °F (+2 °C to +25 °C)	1	2.2 (1.0)	01362719387



Thermal Storage

EasyHeat™ thermal storage heating cables by Emerson are designed to heat moist sand beds under concrete floors and provide a cost effective supplement to standard heating systems in commercial and industrial buildings. Cables or mats are installed underneath the concrete floor in a prepared sand bed, and energized during the hours when discounted energy is available, storing the generated heat for use after the cable power has been turned off. The sand is charged during periods when electrical energy is less expensive (“off peak”), for discharge during periods of higher energy cost, usually during the day.

EasyHeat™ Thermal Storage Product Selection Guide

Criteria	XD Cables
1. What is the target application?	
Thermal Storage	✓
Interior Supplementary Heat	✓
2. What is the material of the surface floor?	
Concrete	✓
3. What are the layout options?	
Layout Options	Specific length, based on heating requirement within a specific area
4. What is the available supply voltage?	
Supply Voltage (Vac)	208, 240, 277, 480
5. What is the linear nominal power rating?	
Nominal Linear Power Rating	8 Watts/ft
6. What is the available supply voltage?	
Supply Voltage (Vac)	120
Power Cord	6 ft (1.83 m)
7. What is the maximum power rating?	
In Concrete	–
Sand Under Concrete	8 to 24 Watts/ft ²

✓ *Applicable*
 – *Not Applicable*

EasyHeat™ XD Cable Kits

Thermal Storage Cable Kits, Fixed Resistance. For Commercial and Residential Applications.

Product Overview

- XD cable kits are tough, heavy duty heating cables designed specifically for earth thermal storage applications.
- The dual conductor, single end cold lead cable design means easier heating system design and installation.

Applications

- Commercial or residential garages, storage facilities, and warehouses where supplemental floor heat is beneficial and can be obtained during off peak hours when discounted energy is available.

Features

- Supplied with 20 ft (6.10 m) cold leads as standard and made-to-order in 208 Vac and 240 Vac.
- Dual-element, fixed-resistance cables are pre-sized to fit your area and layout requirements.
- One year limited warranty.

Related Products

- Each heating zone requires two thermostats: an adjustable sensing thermostat to control floor temperature at an appropriate setting, and a pre-set high-limit thermostat to ensure heating cable temperature does not exceed design requirements. See EasyHeat™ Thermal Storage Controls.

Certifications

- UL Listed.



Notes

- Per NEC and CEC requirements ALWAYS use a ground fault protection device (GFEP) to reduce the danger of fire from a damaged or improperly installed heating cable. Electrical fault currents caused by damaged or improperly installed cable MAY NOT BE LARGE ENOUGH to trip a conventional circuit breaker.
- Heating cables must be installed in compliance with all national, state/provincial and local codes. Check with your local electrical inspector for specific details.
- Insulation of perimeter foundation walls is required. Insulation under the cable sand bed is optional but improves system performance.
- Sand bed must remain moist, as this greatly enhances the amount of heat the bed can store and promotes heat transfer away from the heating cables.
- It is recommended the heating system be designed to use several smaller wattage cables rather than one large wattage cable. A scaled drawing must be made showing the heating cable layout, related branch circuitry, junction boxes and controls.

Illustrated Features

THERMAL STORAGE

Heater Wire

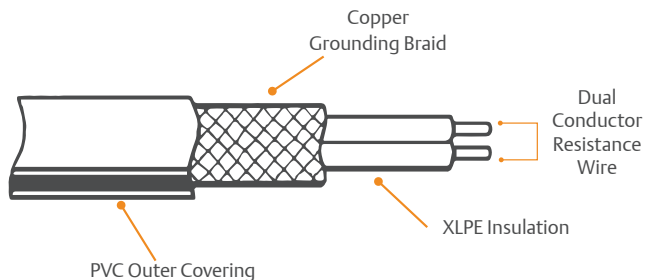

Heater Wire Dimensions 0.260 in x 0.165 in (6.604 mm x 4.191 mm)

Cold Lead

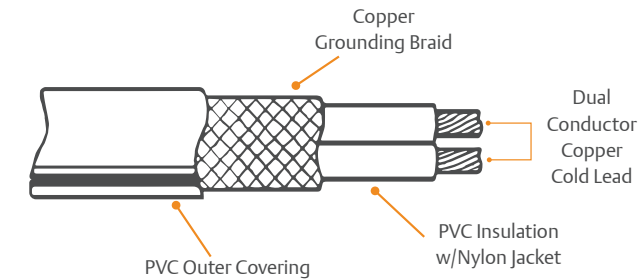

Cold Lead Dimensions: #14 AWG — 0.350 in x 220 in x 10 ft (8.89 mm x 5588 mm x 3 m)
#10 AWG — 0.430 in x 250 in x 10 ft (10.92 mm x 6350 mm x 3 m)

EasyHeat™ XD Cable Kits

Thermal Storage Cable Kits, Fixed Resistance. For Commercial and Residential Applications.

Technical Information

Product Selection

Catalog Number	Description	Carton Quantity	Carton Weight lb (kg)	UPC
XD102	126 ft (38 m) long, 1000 Watts	1	3.8 (1.7)	01362706722
XD152	190 ft (58 m) long, 1500 Watts	1	5.8 (2.6)	01362706726
XD202	253 ft (77 m) long, 2000 Watts	1	8 (3.6)	01362700375
XD252	303 ft (92 m) long, 2500 Watts	1	9 (4.1)	01362706727
XD302	369 ft (113 m) long, 3000 Watts	1	10 (4.5)	01362706720
XD352	435 ft (133 m) long, 3500 Watts	1	11 (5.0)	01362706723
XD402	495 ft (151 m) long, 4000 Watts	1	12 (5.4)	01362706725
XD502	661 ft (202 m) long, 5200 Watts	1	10 (4.5)	01362706724

Thermal Storage Capability

Spacing in (mm)	Watts/ft ²	
	208 Vac	240 Vac
4 (100)	18	24
6 (150)	12	16
8 (200)	9	12
10 (250)	7.2	9.6
12 (300)	6	8

XD Cable Specifications

Catalog Number	Length ft (m)	Nominal Wattage 240 Vac ①	Nominal Amperage 240 Vac ②
XD102	126 (38)	1000	4.2
XD152	190 (58)	1500	6.3
XD202	253 (77)	2000	8.5
XD252	303 (92)	2500	10.4
XD302	369 (113)	3000	12.5
XD352①	435 (133)	3500	14.7
XD402①	495 (151)	4000	16.7
XD502①	661 (202)	5200	21.9

① Indicates those cables using #10AWG Cold Leads; all others use #14 AWG. Standard cold lead length is 10 ft (3 m).

② For 208 Vac operation, multiply by 0.75. Standard cables are designed for 240 Vac operation.

EasyHeat™ Thermal Storage Controls

Thermal Storage. For Commercial and Residential Applications.

Product Overview

- EasyHeat™ thermal storage controls are designed for controlling radiant heating.

RHSP1 Radiant Heating System Pack

- The RHSP1 radiant heating system pack components include:
 - One floor warming electronic thermostat and one RK-1 relay kit.
 - The floor warming electronic thermostat is dual 120/240 Vac, integrated GFCI, has responsive buttons, and a large blue backlit LCD display.
- RHSP1 provides a large coverage area using only one thermostat.
- The total maximum load is 24 Amps.
- Designed to maintain thermostat settings when the power circuit is interrupted.
- One year limited warranty.



RHSP1 Radiant Heating System Pack

FC130 Thermostat

- The FC130 preset remote bulb thermostat is pre-set to prevent cables from overheating.
- The switch contacts open when the temperature surrounding the bulb rises above +130 °F (+54 °C) to turn off the heat.
- When the temperature drops, the contacts close to turn on the heat.
- Maximum bulb temperature +165 °F (+74 °C).
- Maximum housing temperature +140 °F (+60 °C).
- One year limited warranty.



FC130 Thermostat

THERMAL STORAGE

Product Selection

Catalog Number	Description	Carton Quantity	Carton Weight lb (kg)	UPC
RHSP1	Radiant heating thermostat pack	1	2 (0.9)	01362701345
FC130	High limit thermostat	1	1 (0.5)	01362706821



Floor Warming

Warm Tiles™ Floor Warming Systems by Emerson remove the chill with a gentle, continuous warmth. Warm Tiles™ may be installed directly over plywood, concrete or cement backerboard substrates. The warming element rests in the mortar below your floor surface. Simple to measure, quick to install and easy to control, Warm Tiles™ delivers affordable luxury.

Warm Tiles™ Floor Warming Product Selection Guide

Criteria	DFT	DMC	SAM	WTE
1. What is the target application?				
Typical Application	Residential Commercial	Residential Commercial	Residential Commercial	Residential Commercial
2. Would you prefer a cable or mat?				
Cable	✓	✓	—	—
Mat	—	—	✓	✓
3. What are the layout options?				
Layout Options	Custom, based on area, using strapping	Custom, based on area, using uncoupling membrane	Rectangular	Standard rectangular and custom
4. Can it be used with uncoupling membrane?				
For use with uncoupling membrane	✓①	✓①	—	—
5. What will be your the final floor finish?				
Ceramic/Porcelain Tile	✓	✓	✓	✓
Engineered Wood	✓①	✓①	✓①	✓①
Terrazo	✓	✓	✓	✓
Natural Stone	✓	✓	✓	✓
Laminate floor	✓	✓	✓	✓
Marble	✓	✓	✓	✓
6. What is the subfloor material?				
Exterior Grade Plywood	✓①	✓①	✓①	✓
Existing Ceramic Tile	✓	✓	✓	✓
Concrete/Masonry	✓	✓	✓	✓
Cement Backer Boards	✓	✓	✓	✓
Properly prepared Vinyl	✓①	✓①	✓①	✓①
Hardwood	✓	✓	✓	✓
7. What is the available supply voltage?				
Supply Voltage (Vac)	120, 240	120, 240	120, 240	120, 240
8. What is cold lead length?				
Standard Cold Lead Length	10 ft (3 m)	10 ft (3 m)	15 ft (4.6 m)	15 ft (4.6 m)

✓ Applicable

— Not Applicable

① Verify with your local EasyHeat sales representative.

Warm Tiles™ DFT Cables

Floor Warming Cables. For Residential and Commercial Applications.

Product Overview

- Warm Tiles Floor Warming Cables (DFT) provide for a custom layout, based solely on walkable area.
- Plastic strapping with two different spacing options allow for the design of oversized heat output for concrete slab floors.

Applications

- DFT cables are designed to gently and evenly warm flooring materials such as:
 - Ceramic, porcelain or glass tile
 - Marble, granite or slate
 - Laminate hardwoods
 - LVT (Luxury Vinyl Tile)
 - Stone (poured or dimensional)

Features

- Available in 120 and 240 Vac kits.
- Easily installed on subfloor or concrete slab, in thin-set or self-leveling compound materials.
- Supplied with standard 10 ft (3.05 m) cold leads, DFT cables are designed to supply at least 12 W/ft² – 15 W/ft² when installed per instructions.
- Low profile cable thickness with minimal increase in floor height.
- Included plastic strapping strips secure the DFT cable and plastic clips secure the floor temperature probe.
- Designed with different cable spacing options for more optimal heating performance to accommodate varying heat loss in different installation environments.
- DFT Cable Strapping is constructed of an all plastic material which does not tear, cut or harm the cable in any way during installation and can help to protect the cable from damage when walked on or from objects dropped onto it.
 - Strips come in one foot increments, with mating tabs to connect multiple strips together for an unlimited length run.
 - Strapping lays perfectly flat, keeping the cables low to the surface and minimizing any height increases to the floor.
 - Our rounded channel design allows the cable to glide smoothly when tensioning and will not bend or cause pinch points.
- Can also be installed within an uncoupling membrane. *Contact your local sales representative for details.*
- Fifteen year limited warranty.

Accessories

- It is recommended that a floor temperature sensing thermostat be used to control the cable system. *See Warm Tiles Thermostats.*
- Relays can be used in conjunction with a thermostat to control large heated areas where the power requirement exceeds 15 Amps. We offer relay kits for use with thermostats. *See Warm Tiles Floor Warming Accessories.*

Certifications

- UL Listed, CSA Certified and conform to European Directives.

Included in Box

- DFT cable, plastic strapping, floor temperature probe with 15 ft (3 m) lead, probe/cable clips, tri-language Installation Instructions.



Notes

- Per NEC and CEC requirements **ALWAYS** use a ground fault protection device (GFCI) to reduce the danger of fire from a damaged or improperly installed heating cable. Electrical fault currents caused by damaged or improperly installed cable **MAY NOT BE LARGE ENOUGH** to trip a conventional circuit breaker.
- Heating cables must be installed in compliance with all national, state/provincial and local codes. Check with your local electrical inspector for specific details.
- The Warm Tiles heating cables must be completely embedded in a cement-based layer of mortar prior to installation of the flooring material. DFT cable with strapping will add approximately 0.21 in (6 mm) to the floor height. If cables are exposed, they could be damaged which would expose live electrical parts and/or cause the cable to overheat.
- Cables are designed as a supplementary heat source and not as a primary source of space heating for any room in which it is installed.
- Floor areas may be warmed with a single cable or by using a combination of cables, provided the area to be heated is equal to the sum of the coverage area of the individual cables.
- Heating cable must not touch, cross or overlap itself at any point and cable must not be closer than 1-1/2 in (38 mm) to adjacent cable.
- **DO NOT** install heating cable under any type of nailed-down or stapled flooring. Floor nails and staples can damage the cable resulting in exposed live electrical parts and/or result in the cable overheating.
- **DO NOT** bend the heating cable at right angles – this could damage the electrical insulation; minimum bending radius is 3/4 in (19 mm).
- **DO NOT CUT THE HEATING CABLE.** Only the cold lead may be cut to suit hook-up in the electrical connection box (ECB).

Warm Tiles™ DFT Cable

Floor Warming Cables. For Residential and Commercial Applications.

Measuring Walkable Area

Warm Tiles Warming Cables (DFT) provide unlimited design configurations for even the most difficult shaped room. The Warm Tiles cable allows you to install full floor warming coverage by lacing the cable on the floor wherever you require a heated area. Find each floor section's square area by multiplying the length and width of each walkable floor section. Then add each floor section's walkable square area together for the installation's total walkable square area.

DFT Cable Kit Room Measurement Diagram

Shaded areas represent installation area of your DFT cable system.

A is 2 ft 6 in x 3 ft = 7.5 ft² (0.76 m x 0.91 m = 0.69 m²)

B is 2 ft 6 in x 2 ft ÷ 2 = 2.5 ft² [(0.76 m x 0.61 m) ÷ 2 = 0.23 m²]

C is 3 ft x 5 ft = 15 ft² (0.91 m x 1.52 m = 1.39 m²)

A + B + C = ft² (m²) total walkable heated area

7.5 ft² + 2.5 ft² + 15 ft² = 25 ft²

(0.69 m² + 0.23 m² + 1.39 m² = 2.31 m²) total heated area

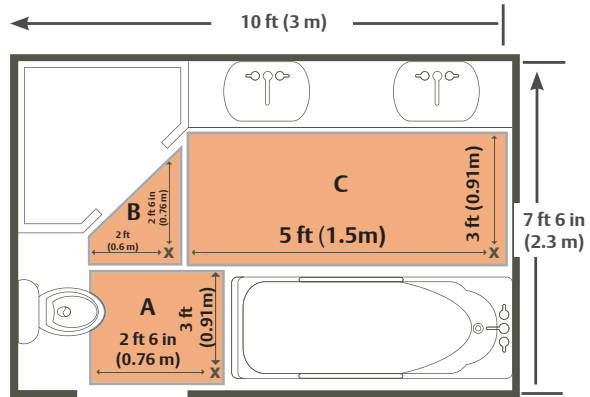

FLOOR WARMING

DFT Cable Kit Room Layout Diagram

Choose the product that most closely matches your heated area square footage from the product selection for Warm Tiles Cable Kits.

In this example, you would choose 120 Vac DFT 1022 cable kit for standard spacing or DFT 1030 for alternate spacing.

For additional layouts or help in choosing the right product for your project, contact your local sales representative.

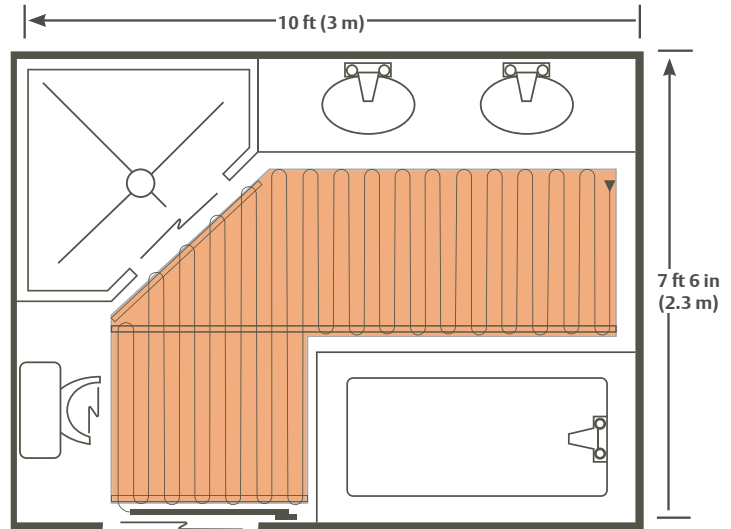

Warm Tiles™ DFT Cable

Floor Warming Cables. For Residential and Commercial Applications.

Considerations For Choosing a Cable

Floor areas may be warmed with a single cable or by using a combination of cables, provided the area to be heated is equal to the sum of the coverage area of the individual cables. Cables are normally installed using a 3 in (76.2 mm) spacing between cable runs (Standard Heating Cable Spacing). For rooms located above unheated areas, including concrete slabs on grade, the recommended spacing is 3 in – 2 in – 3 in – 2 in (75 mm -50 mm -75 mm -50 mm), etc., between cable runs (Alternating Heating Cable Spacing). The same spacing should be used over the entire installation, as non-uniform spacing will result in areas that are either significantly cooler or warmer than other areas. It is recommended to carefully measure the actual floor area to be heated (Heated Area) and use the product selection chart to verify that each cable is the correct size and voltage. Select 120 Vac or 240 Vac to match your power supply.

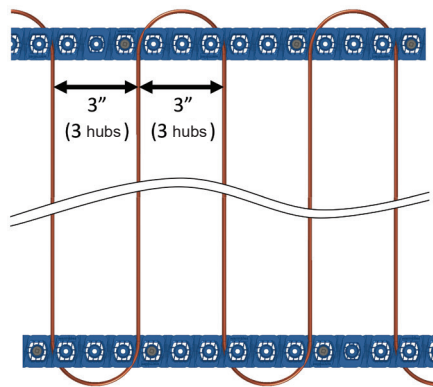

Standard Cable Spacing
3 in (75 mm)
spacing between cable runs

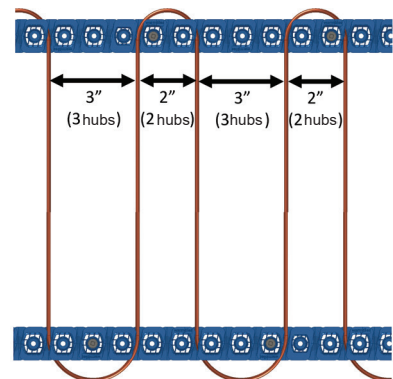

Alternating Cable Spacing
3 in – 2 in – 3 in – 2 in (75 mm -50 mm -75 mm -50 mm)
spacing between cable runs

FLOOR WARMING

DFT 120 Vac Cable Kits

Model	Heated Area ft ² (m ²)		Amps ①
	Standard	Alternating	
DFT 1011	10 - 13 (0.9 - 1.2)	8 - 10 (0.7 - 0.9)	1.1
DFT 1016	14 - 18 (1.3 - 1.7)	11 - 14 (1.0 - 1.3)	1.6
DFT 1022	19 - 26 (1.8 - 2.4)	15 - 22 (1.4 - 2.0)	2.2
DFT 1030	27 - 34 (2.5 - 3.2)	23 - 28 (2.2 - 2.6)	3.0
DFT 1039	35 - 42 (3.3 - 3.9)	29 - 35 (2.7 - 3.3)	4.0
DFT 1048	43 - 54 (4.0 - 5.0)	36 - 45 (3.3 - 4.2)	5.1
DFT 1059	55 - 65 (5.1 - 6.0)	46 - 54 (4.3 - 5.0)	6.4
DFT 1069	66 - 72 (6.1 - 6.7)	55 - 60 (5.1 - 5.6)	7.4
DFT 1079	73 - 82 (6.8 - 7.6)	61 - 68 (5.7 - 6.3)	8.5
DFT 1088	83 - 92 (7.7 - 8.5)	69 - 76 (6.4 - 7.1)	8.8
DFT 1098	93 - 102 (8.6 - 9.5)	77 - 84 (7.2 - 7.8)	9.6
DFT 1108	103 - 113 (9.6 - 10.5)	85 - 95 (7.9 - 8.8)	10.7

DFT 240 Vac Cable Kits

Model	Heated Area ft ² (m ²)		Amps ①
	Standard	Alternating	
DFT 2021	18 - 25 (1.7 - 2.3)	15 - 21 (1.4 - 1.9)	1.1
DFT 2031	26 - 35 (2.4 - 3.3)	22 - 29 (2.0 - 2.7)	1.6
DFT 2053	48 - 55 (4.5 - 5.1)	40 - 46 (3.7 - 4.3)	2.6
DFT 2065	60 - 70 (5.6 - 6.5)	50 - 58 (4.6 - 5.4)	3.3
DFT 2078	71 - 83 (6.6 - 7.7)	59 - 70 (5.5 - 6.5)	4.0
DFT 2095	90 - 100 (8.4 - 9.3)	75 - 84 (6.9 - 7.8)	5.1
DFT 2118	110 - 130 (10.2 - 12.1)	91 - 108 (8.5 - 10.0)	6.3
DFT 2137	131 - 145 (12.2 - 13.5)	109 - 120 (10.1 - 11.1)	7.4
DFT 2157	146 - 165 (13.6 - 15.3)	121 - 137 (11.2 - 12.7)	8.5
DFT 2175	166 - 184 (15.4 - 17.1)	138 - 153 (12.8 - 14.2)	8.8
DFT 2195	185 - 204 (17.2 - 19.0)	154 - 169 (14.3 - 15.7)	9.6
DFT 2215	205 - 225 (19.1 - 20.9)	170 - 187 (15.8 - 17.4)	10.7

① Caution: Kit combinations that exceed 10 Amps should be connected by a qualified electrician.

Warm Tiles™ DFT Cable

Floor Warming Cables. For Residential and Commercial Applications.

Product Selection

120 Vac						
Catalog Number	Description	Heated Area ft ² (m ²)		# of Strips Included	Shipping Weight lb (kg)	UPC
		Standard ①	Alternating ②			
DFT1011	"Blue" cable kit	10 - 13 (0.9 - 1.2)	8 - 10 (0.7 - 0.9)	9	4 (2)	01362701611
DFT1016	"Red" cable kit	14 - 18 (1.3 - 1.7)	11 - 14 (1.0 - 1.3)	12	4 (2)	01362701612
DFT1022	"Green" cable kit	19 - 26 (1.8 - 2.4)	15 - 22 (1.4 - 2.0)	18	4.5 (2)	01362701613
DFT1030	"Yellow" cable kit	27 - 34 (2.5 - 3.2)	23 - 28 (2.2 - 2.6)	23	9.5 (4.3)	01362701614
DFT1039	"Purple" cable kit	35 - 42 (3.3 - 3.9)	29 - 35 (2.7 - 3.3)	23	5 (3)	01362701615
DFT1048	"Orange" cable kit	43 - 54 (4.0 - 5.0)	36 - 45 (3.3 - 4.2)	41	6 (3)	01362701616
DFT1059	"Brown" cable kit	55 - 65 (5.1 - 6.0)	46 - 54 (4.3 - 5.0)	41	7 (3)	01362701617
DFT1069	"Sage" cable kit	66 - 72 (6.1 - 6.7)	55 - 60 (5.1 - 5.6)	44	7 (3)	01362701618
DFT1079	"White" cable kit	73 - 82 (6.8 - 7.6)	61 - 68 (5.7 - 6.3)	50	7 (3.2)	01362701619
DFT1088	"Pink" cable kit	83 - 92 (7.7 - 8.5)	69 - 76 (6.4 - 7.1)	50	7.5 (3.4)	01362701609
DFT1098	"Silver" cable kit	93 - 102 (8.6 - 9.5)	77 - 84 (7.2 - 7.8)	59	8 (3.6)	01362701608
DFT1108	"Black" cable kit	103 - 113 (9.6 - 10.5)	85 - 95 (7.9 - 8.8)	65	8.5 (3.9)	01362701607

240 Vac						
Catalog Number	Description	Heated Area ft ² (m ²)		# of Strips Included	Shipping Weight lb (kg)	UPC
		Standard ①	Alternating ②			
DFT2021	"A" cable kit	18 - 25 (1.7 - 2.3)	15 - 21 (1.4 - 1.9)	17	8 (3.6)	01362701621
DFT2031	"B" cable kit	26 - 35 (2.4 - 3.3)	22 - 29 (2.0 - 2.7)	24	10 (4.5)	01362701622
DFT2053	"C" cable kit	48 - 55 (4.5 - 5.1)	40 - 46 (3.7 - 4.3)	42	12 (5.4)	01362701623
DFT2065	"D" cable kit	60 - 70 (5.6 - 6.5)	50 - 58 (4.6 - 5.4)	50	15.4 (7)	01362701624
DFT2078	"E" cable kit	71 - 83 (6.6 - 7.7)	59 - 70 (5.5 - 6.5)	50	16.2 (7.4)	01362701625
DFT2095	"F" cable kit	90 - 100 (8.4 - 9.3)	75 - 84 (6.9 - 7.8)	75	18.7 (8.5)	01362701626
DFT2118	"G" cable kit	110 - 130 (10.2 - 12.1)	91 - 108 (8.5 - 10.0)	75	21.2 (9.6)	01362701627
DFT2137	"H" cable kit	131 - 145 (12.2 - 13.5)	109 - 120 (10.1 - 11.1)	75	22 (10)	01362701628
DFT2157	"I" cable kit	146 - 165 (13.6 - 15.3)	121 - 137 (11.2 - 12.7)	100	12 (5.4)	01362701629
DFT2175	"J" cable kit	166 - 184 (15.4 - 17.1)	138 - 153 (12.8 - 14.2)	100	12.7 (5.7)	01362701630
DFT2195	"K" cable kit	185 - 204 (17.2 - 19.0)	154 - 169 (14.3 - 15.7)	125	13.8 (6.3)	01362701631
DFT2215	"L" cable kit	205 - 225 (19.1 - 20.9)	170 - 187 (15.8 - 17.4)	125	15.1 (6.8)	01362701632

DFT Strapping Kit Product Selection

Catalog Number	Description	Dimensions in (mm)	Package Quantity	Weight lb (kg)	UPC
DFTS	One foot plastic strapping strips with built-in mating inter-connecting male/female connectors	5" x 15" (125 mm x 375 mm)	10	0.9 (0.4)	013627001370

All DFT cable kits include enough strapping to secure cable for square or rectangular rooms without center runs. *For hallways and non-standard sized rooms, additional strapping strips may be needed (sold separately).*

The DFTS Plastic strapping strip kit gives an installer the additional strapping strips needed for long narrow hallways and non-standard room configurations. These include areas such as:

- Long, narrow hallways
- Irregularly shaped rooms
- Areas with curves, angles, or around the-corner bends
- Kitchens with an island
- Basements with large supporting posts/columns

① Use standard spacing on floors that are located above heated areas.

② Use alternating spacing on concrete slab floors or in rooms with excessive heat loss such as solariums.

Warm Tiles™ DMC Series

Floor Warming Cable for use with Uncoupling Membrane. For Residential and Commercial Applications.

Product Overview

- Warm Tiles Electric Floor Warming Cable for Uncoupling Membrane (DMC) is the easy-to-install, reliable solution for your floor warming project.
- The cable was specially designed to be used with all available uncoupling membranes, so installation could not be simpler.

Applications

- DMC cables are designed to gently warm flooring materials such as:
 - Marble
 - Ceramic
 - Glass and porcelain tile
 - Slate
 - Granite
 - Poured or dimensional stone
 - Laminate and certain engineered hardwood products

Features

- Available in 120 and 240 Vac.
- Designed to work with 1.2" (30.5 mm) hub spacing membranes or DMCS strapping strips.
- Heating area range from 7 ft² – 250 ft² (0.7 m² – 23 m²).
- Cable can be laid directly from the spool into the membrane in the optimal spacing configuration for your installation.
- Once the cable is installed, tile installation is easy: self-leveling or scratch coat may not be required.
- Approved for a variety of applications and floor finishes for the ultimate in versatility and compatibility.
- Cables can also be installed in steps, including risers, leading to a bath/shower area in most jurisdictions. *Check with your local electrical inspector before installing in steps.*
- Fifteen year limited warranty.

Accessories

- Our Warm Tiles DMCS Cable Strapping Strips are designed to work exclusively with DMC floor-warming cables. See *Warm Tiles DMCS Cable Strapping Strips*.
- It is recommended that a floor temperature sensing thermostat be used to control the cable system. See *Warm Tiles Thermostats*.
- Relays can be used in conjunction with a thermostat to control large heated areas where the power requirement exceeds 15 Amps. We offer relay kits for use with thermostats. See *Warm Tiles Floor Warming Accessories*.

Certifications

- CSA Certified for use in both the U.S. and Canada.

Included in Box

- DMC cable, Tri-Language Instructions.

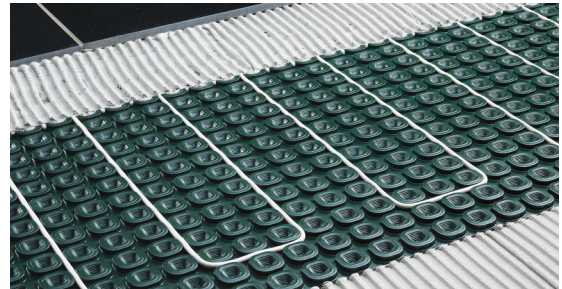
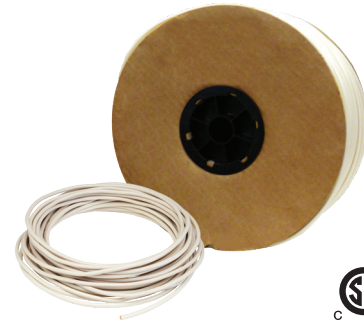

Notes

- Per NEC and CEC requirements **ALWAYS** use a ground fault protection device (GFCI) to reduce the danger of fire from a damaged or improperly installed heating cable. Electrical fault currents caused by damaged or improperly installed cable **MAY NOT BE LARGE ENOUGH** to trip a conventional circuit breaker.
- Heating cables must be installed in compliance with all national, state/provincial and local codes. Check with your local electrical inspector for specific details.
- The Warm Tiles heating cables must be completely embedded in a cement-based layer of mortar prior to installation of the flooring material. DMC cable with uncoupling membrane will add approximately 0.387 in (9.83 mm) to the floor height.
- Cables are not designed as a primary source of space heating for any room in which it is installed.
- Heating cable must not touch, cross or overlap itself at any point.
- **DO NOT** install heating cable under any type of nailed-down or stapled flooring. Floor nails and staples can damage the cable resulting in exposed live electrical parts and/or result in the cable overheating.
- Warm Tiles cables may not be installed under natural wood floors because the heat from the cables will cause these floors to warp, crack and/or discolor. Before beginning installation, check with the flooring manufacturer to verify that their materials are suitable for electric radiant underfloor heating.
- **DO NOT** bend the heating cable at right angles – this could damage the electrical insulation; minimum bending radius is 3/4 in (19 mm).
- **DO NOT CUT THE CABLE.** Only the cold lead may be cut to suit hook-up in the electrical connection box (ECB).

Warm Tiles™ DMC Cable

Floor Warming Cable for use with Uncoupling Membrane. For Residential and Commercial Applications.

Measuring Walkable Area

Warm Tiles Electric Floor Warming Cable for Uncoupling Membrane (DMC) is designed to be used with all available uncoupling membranes and can be laid directly from the spool into the membrane in whatever configuration you need. DMC allows you to install full floor warming coverage wherever you require a heated area. Find each floor section's square area by multiplying the length and width of each walkable floor section. Then add each floor section's walkable square area together for the installation's total walkable square area.

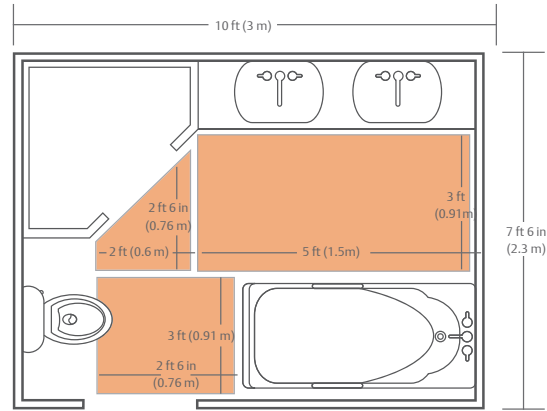

Cable Spacing

Floor areas may be warmed with a single cable or by using a combination of cables, provided the area to be heated is equal to the sum of the coverage area of the individual cables. Use standard cable spacing for rooms above heated areas. Dense cable spacing can be used for rooms above unheated areas, concrete slabs or high heat loss areas. Alternating cable spacing is used for excess cable or compensating for cable shortage. The same spacing should be used over the entire installation, as non-uniform spacing will result in areas that are either significantly cooler or warmer than other areas.

FLOOR WARMING

DMC Cable Spacing with Uncoupling Membrane

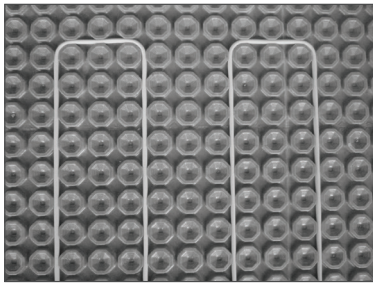

Standard Cable Spacing

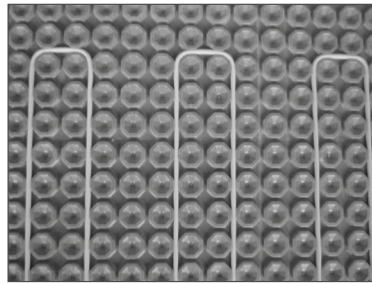

Alternating Cable Spacing

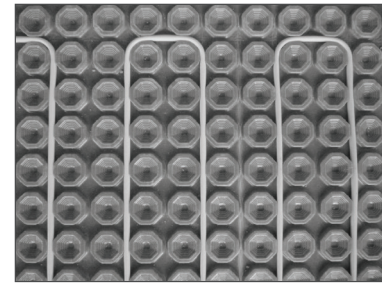

Dense Cable Spacing

DMC Cable Spacing with DMCS Strapping Strips

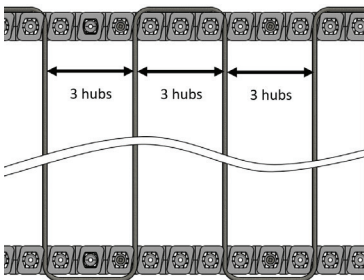

Standard Cable Spacing

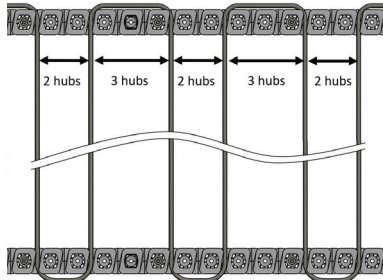

Alternating Cable Spacing

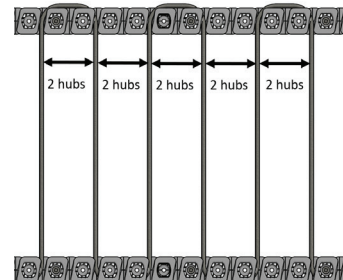

Dense Cable Spacing

Cables are spaced 3 channels/hubs apart. This results in spacing of 3-3/4 in (90 mm) between cables and provides 12 W/ft².

Cables are spaced alternately 3 channels/hubs apart and 2 channels/hubs apart. This results in spacing of 3-3/4 in (90 mm) and 2-1/2 in (60 mm) between cables and provides 15 W/ft².

Cables are spaced 2 channels/hubs apart. This results in spacing of 2-1/2 in (60 mm) between cables and provides 18 W/ft².

Warm Tiles™ DMC Cable

Floor Warming Cable for use with Uncoupling Membrane. For Residential and Commercial Applications.

Cable Length and Power Supply

It is recommended to carefully measure the actual floor area to be heated (Heated Area) and use the product selection chart to verify that each cable is the correct size and voltage. Select 120 Vac or 240 Vac to match your power supply. 240 Vac is generally more economical for areas larger than 70 ft² (6.50 m²). The following heating area tables are based on membranes with 1.25 in (32 mm) spacing. For membranes with other spacing, contact your local sales representative for more information.

DMC 120 Vac Cable Kits

Model Number	Heating Area ft ² (m ²)			Cable Length ft (m)	Current Amps
	Standard Spacing (cables are spaced 3 channels apart) ①	Alternative Spacing (cables are spaced 2 channels apart and 3 channels apart) ②	Dense Spacing (cables are spaced 2 channels apart) ③		
DMC 1012	13-15 (1.2-1.4)	11-12 (1.0-1.2)	8-10 (0.8-0.9)	44 (13)	1.3
DMC 1016	16-20 (1.5-1.9)	13-17 (1.2-1.6)	11-14 (1.0-1.3)	58 (18)	1.7
DMC 1021	22-25 (2.0-2.4)	18-21 (1.7-2.0)	15-17 (1.4-1.6)	76 (23)	2.3
DMC 1025	25-30 (2.3-2.7)	21-25 (1.9-2.3)	17-20 (1.6-1.8)	88 (27)	2.6
DMC 1031	31-37 (2.9-3.5)	26-31 (2.4-2.9)	21-25 (1.9-2.3)	109 (33)	3.3
DMC 1042	39-52 (3.6-4.8)	33-43 (3.0-4.0)	26-34 (2.4-3.2)	145 (44)	4.4
DMC 1053	53-63 (4.9-5.8)	44-52 (4.1-4.9)	35-42 (3.3-3.9)	185 (56)	5.5
DMC 1065	63-77 (5.8-7.1)	52-64 (4.9-5.9)	42-51 (3.9-4.8)	224 (68)	6.7
DMC 1081	80-94 (7.4-8.7)	66-78 (6.2-7.3)	53-63 (4.9-5.8)	277 (85)	8.3
DMC 1097	96-112 (8.9-10.4)	80-94 (7.4-8.7)	64-75 (5.9-7.0)	333 (102)	10.0
DMC 1114	111-134 (10.3-12.5)	92-112 (8.6-10.4)	74-90 (6.9-8.3)	392 (120)	11.8

DMC 240 Vac Cable Kits

Model Number	Heating Area ft ² (m ²)			Cable Length ft (m)	Current Amps
	Standard Spacing (cables are spaced 3 channels apart) ①	Alternative Spacing (cables are spaced 2 channels apart and 3 channels apart) ②	Dense Spacing (cables are spaced 2 channels apart) ③		
DMC 2021	22-25 (2.0-2.3)	18-21 (1.7-1.9)	14-17 (1.3-1.5)	75 (23)	1.1
DMC 2025	25-30 (2.4-2.8)	21-25 (2.0-2.3)	17-20 (1.6-1.8)	88 (27)	1.3
DMC 2031	31-37 (2.9-3.5)	26-31 (2.4-2.9)	21-25 (1.9-2.3)	109 (33)	1.6
DMC 2042	39-52 (3.6-4.8)	33-43 (3.0-4.0)	26-34 (2.4-3.2)	145 (44)	2.2
DMC 2054	54-64 (5.0-6.0)	45-53 (4.2-5.0)	36-43 (3.3-4.0)	189 (58)	2.8
DMC 2063	62-75 (5.7-7.0)	52-62 (4.8-5.8)	41-50 (3.8-4.6)	219 (67)	3.3
DMC 2081	79-97 (7.3-9.0)	65-80 (6.1-7.5)	52-64 (4.9-6.0)	280 (85)	4.2
DMC 2097	94-114 (8.7-10.6)	78-95 (7.3-8.9)	63-76 (5.8-7.1)	333 (102)	5.0
DMC 2113	112-130 (10.4-12.1)	94-109 (8.7-10.1)	75-87 (7.0-8.1)	389 (118)	5.8
DMC 2131	130-150 (12.1-13.9)	108-125 (10.1-11.6)	87-100 (8.0-9.3)	447 (136)	6.7
DMC 2163	157-190 (14.5-17.7)	131-158 (12.1-14.7)	104-127 (9.7-11.8)	555 (169)	8.3
DMC 2196	190-227 (17.7-21.1)	158-189 (14.7-17.5)	127-151 (11.8-14.0)	667 (203)	10.0
DMC 2231	225-265 (20.9-24.6)	187-221 (17.4-20.5)	150-177 (13.9-16.4)	785 (239)	11.8

① Standard for 12 W/ft².

② Alternate for 15 W/ft².

③ Dense for 18 W/ft².

Warm Tiles™ DMC Cable

Floor Warming Cable for use with Uncoupling Membrane. For Residential and Commercial Applications.

Product Selection

120 Vac					
Catalog Number	Cable Length ft (m)	Power Consumption (Watts)	Carton Quantity	Carton Weight lb (kg)	UPC
DMC1012	44 (13)	159	2	2.1 (1.0)	01362718810
DMC1016	58 (18)	208	2	2.7 (1.2)	01362718811
DMC1021	76 (23)	274	2	3.1 (1.4)	01362718812
DMC1025	88 (27)	315	2	3.4 (1.5)	01362718813
DMC1031	109 (33)	394	2	3.6 (1.6)	01362718814
DMC1042	145 (44)	522	2	4.0 (1.8)	01362718815
DMC1053	185 (56)	665	2	4.6 (2.1)	01362718816
DMC1065	224 (68)	805	2	5.6 (2.5)	01362718817
DMC1081	277 (85)	998	2	7.2 (3.2)	01362718818
DMC1097	333 (102)	1200	2	8.7 (3.9)	01362718819
DMC1114	392 (120)	1412	2	10.3 (4.6)	01362718820

240 Vac					
Catalog Number	Cable Length ft (m)	Power Consumption (Watts)	Carton Quantity	Carton Weight lb (kg)	UPC
DMC2021	75 (23)	268	2	2.5 (1.1)	01362718821
DMC2025	88 (27)	317	2	3.0 (1.4)	01362718822
DMC2031	109(33)	393	2	3.6 (1.6)	01362718823
DMC2042	145 (44)	522	2	4.7 (2.1)	01362718824
DMC2054	189 (58)	679	2	6.2 (2.8)	01362718825
DMC2063	219 (67)	788	2	7.1 (3.2)	01362718826
DMC2081	280 (85)	1008	2	9.1 (4.1)	01362718827
DMC2097	333 (102)	1200	2	10.9 (4.9)	01362718828
DMC2113	389 (118)	1399	2	12.7 (5.7)	01362718829
DMC2131	447 (136)	1610	2	14.6 (6.6)	01362718830
DMC2163	555 (169)	1997	2	15.5 (7.0)	01362718831
DMC2196	667 (203)	2400	2	16.3 (7.3)	01362718832
DMC2231	785 (239)	2824	2	19.0 (8.6)	01362718833

FLOOR WARMING

Warm Tiles™ SAM Mat

Floor Warming Self-Adhesive Mat. For Commercial and Residential Applications.

Product Overview

- Warm Tiles™ Self-Adhesive Mats (SAM) are ideally suited for rectangular areas, multi-unit applications, or expansive rooms.
- The cable is fixed onto a mesh substrate and comes in standard sizes of pre-fabricated rectangular mats with self-adhesive, wide-spaced backing to help reduce installation time and labor.

Applications

- SAM mats are designed to gently warm flooring materials such as:
 - Marble
 - Ceramic
 - Glass and porcelain tile
 - Slate
 - Granite
 - Poured or dimensional stone
 - Laminate and engineered hardwood products

Features

- Available in 120 and 240 Vac with standard 15 ft (4.6 m) cold leads.
- Ideal for large areas, just roll out and affix to the subfloor.
- Mats can be altered in the field to fit various floor layouts.
- Comes in standard 20 in (0.51 m) rolls that are easy to stock and carry to the jobsite.
- Provides 15 W/ft², 14 W/ft² for select models, to quickly and efficiently warm floors.
- Plastic mesh substrate (not cable) can be cut to allow for additional layout customization.
- Custom mats are available for various shaped areas that do not conform to standard mat kits, such as ovals, circles and triangles. Contact your local representative for details.
- Approved for a variety of applications and floor finishes for the ultimate in versatility and compatibility.
- Cables can be installed in tiled showers or other wet areas, although it is recommended that you check with your local electrical inspector first to verify that this application is allowed in your jurisdiction.
- Fifteen year limited warranty.

Accessories

- It is recommended that a floor temperature sensing thermostat be used to control the cable system. See *Warm Tiles™ Thermostats*.
- Relays can be used in conjunction with a thermostat to control large heated areas, where the power requirement exceeds 15 amps. See *Warm Tiles™ Floor Warming Accessories*.

Certifications

- UL Listed, CSA Certified and conform to European Directives.



Notes

- Per NEC and CEC requirements ALWAYS use a ground fault protection device (GFCI) to reduce the danger of fire from a damaged or improperly installed heating cable. Electrical fault currents caused by damaged or improperly installed cable MAY NOT BE LARGE ENOUGH to trip a conventional circuit breaker.
- Heating cables must be installed in compliance with all national, state/provincial and local codes. Check with your local electrical inspector for specific details.
- The Warm Tiles™ heating cables must be completely embedded in a cement-based layer of mortar prior to installation of the flooring material. SAM will add approximately 0.387 in (9.83 mm) to the floor height.
- Mats are not designed as a primary source of space heating for any room in which it is installed.
- Heating cable must not touch, cross or overlap itself at any point.
- Do not install heating cable under carpet, vinyl composition or linoleum type floors, or any type of nailed-down wood flooring. Floor nailing can damage the cable resulting in exposed live electrical parts and/or result in the cable overheating.
- Do not bend the heating cable at right angles – this could damage the electrical insulation; minimum bending radius is 3/4 in (19 mm).
- The heating cable of the mat must not extend beyond the room or area in which it originates.
- **DO NOT CUT THE CABLE.** Only the cold lead may be cut to suit hook-up in the electrical connection box (ECB).
- Always complete the installation resistance log and submit a copy to the owner. Take photos of the installation for record.

Warm Tiles™ SAM Mat

Floor Warming Self-Adhesive Mat. For Commercial and Residential Applications.

Measuring Walkable Area

Warm Tiles™ Self-Adhesive Mats (SAM) mesh substrate is self-adhesive allowing you to place the mat on the subfloor and have it stay put while you embed the mat in thin-set or self-leveling underlayment. Various floor areas may be warmed with a single mat or by using a combination of mats. Find each floor section's square area by multiplying the length and width of each walkable floor section. Then add each floor section's walkable square area together for the installation's total walkable square area.

Cable Kit Room Measurement Diagram

Shaded areas represent installation areas of your mat system.

A is 1 ft 8 in x 6 ft 6 in = 10.86 ft² (0.51 m x 1.98 m = 1.01 m²)

B is 1 ft 8 in x 6 ft 6 in = 10.86 ft² (0.51 m x 1.98 m = 1.01 m²)

C is 1 ft 8 in x 6 ft 6 in = 10.86 ft² (0.51 m x 1.98 m = 1.01 m²)

D is 1 ft 8 in x 2 ft 6 in = 4.18 ft² (0.51 m x 0.76 m = 0.39 m²)

A + B + C + D = ft² (m²) total walkable heated area

10.86 ft² + 10.86 ft² + 10.86 ft² + 4.18 ft² = **36.78 ft²**

(1.01 m² + 1.01 m² + 1.01 m² + 0.39 m²) = **3.42 m²** total heated area

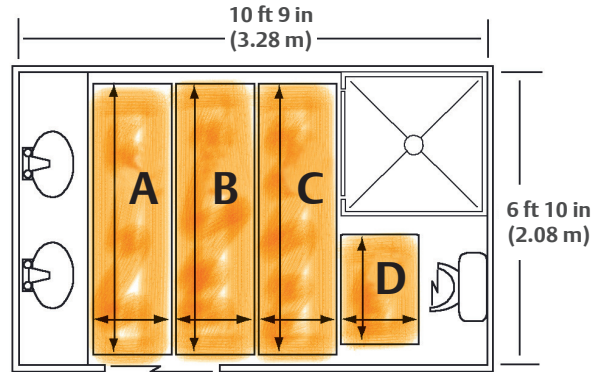

Cable Kit Room Layout Diagram

Choose the product that most closely matches your heated area square footage from the product selection chart for SAM mat kits.

In this example, you would choose 120 Vac SAM 1033 mat kit.

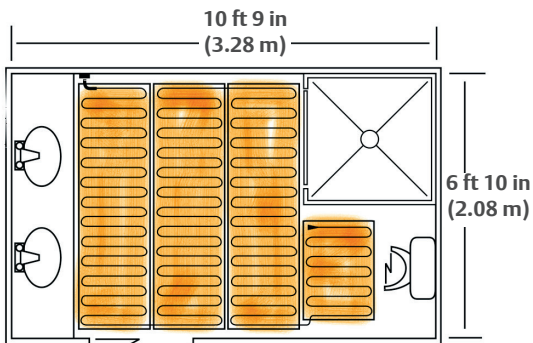

For additional layouts or help in choosing the right product for your project, contact your local sales representative.

In this example, you would choose 120 Vac SAM 1087 mat kit.

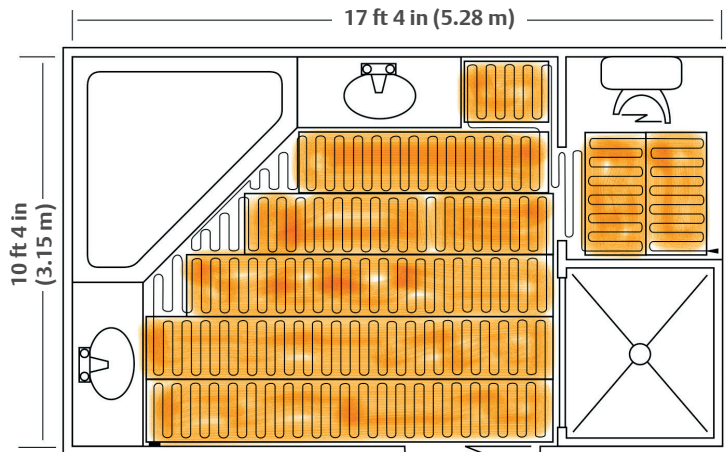

Warm Tiles™ SAM Mat

Floor Warming Self-Adhesive Mat. For Commercial and Residential Applications.

Considerations For Choosing a Mat

Choose between 120 Vac or 240 Vac, to match your power supply. For areas larger than about 70 ft² (6.50 m²), the 240 Vac kits may be more economical. All mats are 20 in (0.51 m) wide. Multiple mats may be used to increase heated area ft² (m²) of installation.

SAM 120 Vac Mat Kits

Model Number	Mat Length ft (m)	Heated Area ft ² (m ²)	Amps
SAM 1010	6.67 (2.03)	12-15 (1.11-1.39)	1.3
SAM 1013	8.67 (2.64)	16-19 (1.50-1.76)	1.7
SAM 1017	11.33 (3.45)	20-22 (1.86-2.04)	2.2
SAM 1020	13.33 (4.06)	23-28 (2.14-2.60)	2.5
SAM 1025	16.67 (5.08)	29-36 (2.69-3.34)	3.1
SAM 1033	22.00 (6.70)	37-46 (3.44-4.27)	4.2
SAM 1042	28.00 (8.53)	47-54 (4.37-5.02)	5.3
SAM 1050	33.33 (10.15)	55-66 (5.11-6.13)	6.5
SAM 1062	41.33 (12.59)	67-80 (6.22-7.43)	8.1
SAM 1075	50.00 (15.24)	81-94 (7.53-8.73)	9.7
SAM 1087	58.00 (17.68)	95-106 (8.83-9.85)	11.5 Ⓞ
SAM 1100	66.67 (20.32)	107-120 (9.94-11.15)	13.1 Ⓞ

SAM 240 Vac Mat Kits

Model Number	Mat Length ft (m)	Heated Area ft ² (m ²)	Amps
SAM 2010	6.67 (2.03)	12-15 (1.11-1.39)	0.6
SAM 2013	8.67 (2.64)	16-19 (1.50-1.76)	0.8
SAM 2017	11.33 (3.45)	20-22 (1.86-2.04)	1.1
SAM 2020	13.33 (4.06)	23-28 (2.14-2.60)	1.3
SAM 2025	16.67 (5.08)	29-36 (2.69-3.34)	1.6
SAM 2033	22.00 (6.70)	37-46 (3.44-4.27)	2.1
SAM 2042	28.00 (8.53)	47-54 (4.37-5.02)	2.8
SAM 2050	33.33 (10.15)	55-66 (5.11-6.13)	3.1
SAM 2062	41.33 (12.59)	67-80 (6.22-7.43)	4.1
SAM 2075	50.00 (15.24)	81-94 (7.53-8.73)	4.8
SAM 2087	58.00 (17.68)	95-106 (8.83-9.85)	5.7
SAM 2100	66.67 (20.32)	107-120 (9.94-11.15)	6.5

Ⓞ Caution: Kit combinations that exceed 10 Amps should be connected by a qualified electrician.

Mat Shape Configurations

The heating cable of the SAM mat kit is adhered in a serpentine pattern onto lengths of mesh substrate. It is quick and easy to cover large areas. These mats can be angled, turned or completely flipped around in order to cover the space by cutting only the mesh, and moving the remaining sections of mats in a new direction. In doing this, you are creating as much walkable heated area as possible.

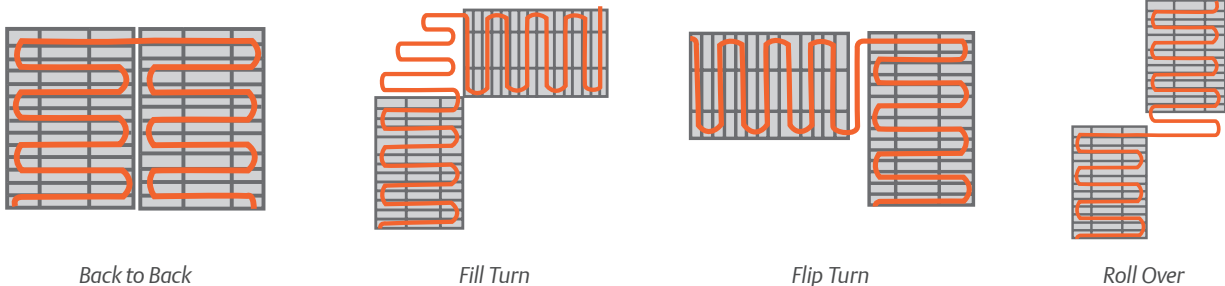

Warm Tiles™ SAM Mat

Floor Warming Self-Adhesive Mat. For Commercial and Residential Applications.

Product Selection

120 Vac					
Catalog Number	Description	Heated Area ft ² (m ²)	Carton Quantity	Carton Weight lb (kg)	UPC
SAM 1010	20 in x 6.67 ft (0.51 x 2.03 m)	12-15 (1.11-1.39)	1	3 (1.4)	01362701561
SAM 1013	20 in x 8.67 ft (0.51 x 2.64 m)	16-19 (1.50-1.76)	1	3.3 (1.5)	01362701562
SAM 1017	20 in x 11.33 ft (0.51 x 3.45 m)	20-22 (1.86-2.04)	1	3.6 (1.6)	01362701563
SAM 1020	20 in x 13.33 ft (0.51 x 4.06 m)	23-28 (2.14-2.60)	1	3.9 (1.8)	01362701564
SAM 1025	20 in x 16.67 ft (0.51 x 5.08 m)	29-36 (2.69-3.34)	1	4.3 (2.0)	01362701565
SAM 1033	20 in x 22 ft (0.51 x 6.71 m)	37-46 (3.44-4.27)	1	4.9 (2.2)	01362701566
SAM 1042	20 in x 28 ft (0.51 x 8.53 m)	47-54 (4.37-5.02)	1	5.3 (2.4)	01362701567
SAM 1050	20 in x 33.33 ft (0.51 x 10.16 m)	55-66 (5.11-6.13)	1	6.2 (2.8)	01362701568
SAM 1062	20 in x 41.33 ft (0.51 x 12.60 m)	67-80 (6.22-7.43)	1	7.5 (3.4)	01362701569
SAM 1075	20 in x 50 ft (0.51 x 15.24 m)	81-94 (7.53-8.73)	1	8.7 (3.9)	01362701570
SAM 1087	20 in x 58 ft (0.51 x 17.68 m)	95-106 (8.83-9.85)	1	9.7 (4.3)	01362701571
SAM 1100	20 in x 66.67 ft (0.51 x 20.32 m)	107-120 (9.94-11.15)	1	10.8 (4.9)	01362701572

240 Vac					
Catalog Number	Description	Heated Area ft ² (m ²)	Carton Quantity	Carton Weight lb (kg)	UPC
SAM 2010	20 in x 6.67 ft (0.51 x 2.03 m)	12-15 (1.11-1.39)	1	3 (1.4)	01362701581
SAM 2013	20 in x 8.67 ft (0.51 x 2.64 m)	16-19 (1.50-1.76)	1	3.3 (1.5)	01362701582
SAM 2017	20 in x 11.33 ft (0.51 x 3.45 m)	20-22 (1.86-2.04)	1	3.6 (1.6)	01362701583
SAM 2020	20 in x 13.33 ft (0.51 x 4.06 m)	23-28 (2.14-2.60)	1	3.9 (1.8)	01362701584
SAM 2025	20 in x 16.67 ft (0.51 x 5.08 m)	29-36 (2.69-3.34)	1	4.3 (2.0)	01362701585
SAM 2033	20 in x 22 ft (0.51 x 6.71 m)	37-46 (3.44-4.27)	1	4.9 (2.2)	01362701586
SAM 2042	20 in x 28 ft (0.51 x 8.53 m)	47-54 (4.37-5.02)	1	5.3 (2.4)	01362701587
SAM 2050	20 in x 33.33 ft (0.51 x 10.16 m)	55-66 (5.11-6.13)	1	6.2 (2.8)	01362701588
SAM 2062	20 in x 41.33 ft (0.51 x 12.60 m)	67-80 (6.22-7.43)	1	7.5 (3.4)	01362701589
SAM 2075	20 in x 50 ft (0.51 x 15.24 m)	81-94 (7.53-8.73)	1	8.7 (3.9)	01362701590
SAM 2087	20 in x 58 ft (0.51 x 17.68 m)	95-106 (8.83-9.85)	1	9.7 (4.3)	01362701591
SAM 2100	20 in x 66.67 ft (0.51 x 20.32 m)	107-120 (9.94-11.15)	1	10.8 (4.9)	01362701592

FLOOR WARMING

Warm Tiles™ Elite WTE Mat

Floor Warming Mats. For Residential and Commercial Applications.

Product Overview

- Warm Tiles™ Elite (WTE) mats are designed for indoor floor warming applications with minimal impact on floor height.
- Mats consist of heating cable interwoven into slim, durable fabric, and come in standard and custom, made-to-order sizes.

Applications

- WTE mats are designed to gently warm flooring materials such as:
 - Marble
 - Ceramic
 - Glass and porcelain tile
 - Slate
 - Granite
 - Poured or dimensional stone
 - Laminate and engineered hardwood products

Features

- Available in 120 and 240 Vac with standard 15 ft (4.57 m) cold leads.
- Thin 0.125 in (3.2 mm) mat means minimal impact on floor height.
- Same-day installation possible due to cost effective fabric mat design.
- High power output up to 15 W/ft², 14 W/ft² for select models, provides ample heat to quickly and efficiently warm up floors.
- Custom mats are available for various shaped areas. Contact your local sales representative for details.
- Cables can be installed in tiled showers or other wet areas, although it is recommended that you check with your local electrical inspector first to verify that this application is allowed in your jurisdiction.
- Fifteen year limited warranty.

Ordering Information

- We can assist you to determine the appropriate WTE mat for your application. Contact your local sales representative for details.

Accessories

- It is recommended that a floor temperature sensing thermostat be used to control the cable system. See *Warm Tiles™ Thermostats*.
- Relays can be used in conjunction with a thermostat to control large heated areas, where the power requirement exceeds 15 amps. See *Warm Tiles™ Floor Warming Accessories*.

Certifications

- UL Listed and CSA Certified.



Notes

- Per NEC and CEC requirements ALWAYS use a ground fault protection device (GFCI) to reduce the danger of fire from a damaged or improperly installed heating cable. Electrical fault currents caused by damaged or improperly installed cable MAY NOT BE LARGE ENOUGH to trip a conventional circuit breaker.
- Heating cables must be installed in compliance with all national, state/provincial and local codes. Check with your local electrical inspector for specific details.
- The Warm Tiles™ heating cables must be completely embedded in a cement-based layer of mortar prior to installation of the flooring material. WTE will add approximately 0.211 in (5.36 mm) to the floor height.
- Do not install heating cable under carpet, vinyl composition or linoleum type floors, or any type of nailed-down wood flooring. Floor nailing can damage the cable resulting in exposed live electrical parts and/or result in the cable overheating.
- Cables are not designed as a primary source of space heating for any room in which it is installed.
- Do not alter the length of the heating cable (inside the heating mat) to suit a floor area larger or smaller than the recommended range for that mat: the cable will overheat or not warm properly. Physical injury or fire may result if altered. Only the cold lead may be cut to suit the location of the electrical connection box.
- When using multiple WTE mats, ensure the outside wire of adjacent mats are within 1-1/2 in (38 mm) to 3 in (76 mm) of one another to ensure the cable spacing and heat distribution are consistent across the floor.
- Spacing closer than 1-1/2 in (38 mm), can cause the cable to overheat. Do not space mats greater than 3 in (76 mm) apart, as the floor will not warm to a comfortable temperature.

Warm Tiles™ Elite WTE Mat

Floor Warming Mats. For Residential and Commercial Applications.

Walkable Area

Warm Tiles™ Elite (WTE) mats allow you to install full floor warming coverage with the least impact on floor level. Various floor areas may be warmed with a single mat or by using a combination of mats.

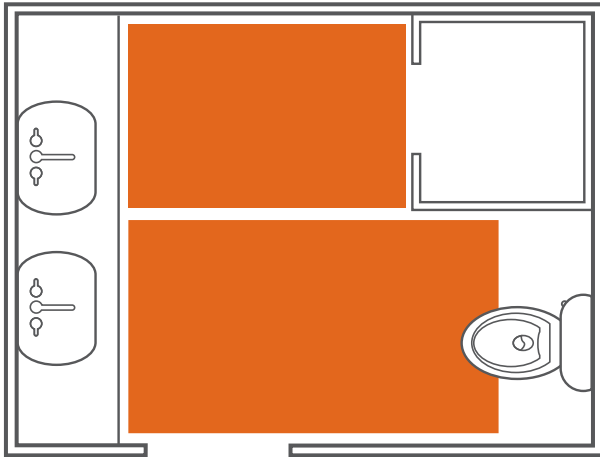

Standard Configuration

Flexible and easy to install. Available in popular sizes for rectangular areas.

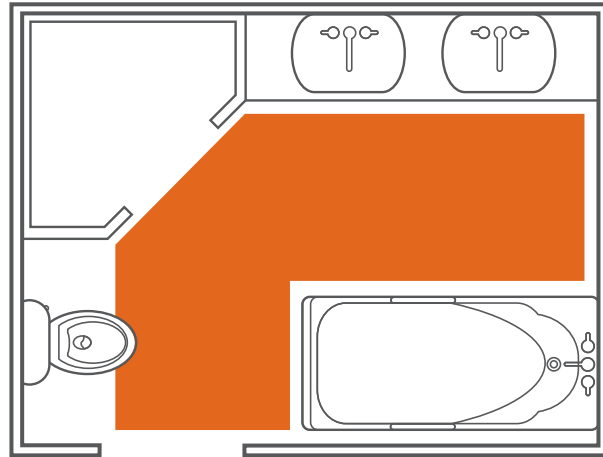

Custom Configuration

Available for coverage in rooms with irregular shapes and obstacles.

FLOOR WARMING

Standard Product Selection for 120 Vac

Catalog Number	Length in (m)	Width in (m)	Heated Area ft ² (m ²)	Carton Quantity	Carton Weight lb (kg)	UPC
WTE0400271	40 (1.02)	27 (0.69)	7.5 (0.70)	1	2.9 (1.3)	01362716538
WTE0400321	40 (1.02)	32 (0.81)	8.9 (0.83)	1	3.0 (1.4)	01362716546
WTE0400401	40 (1.02)	40 (1.02)	11.1 (1.03)	1	3.1 (1.4)	01362716442
WTE0400481	40 (1.02)	48 (1.22)	13.3 (1.24)	1	3.2 (1.5)	01362716537
WTE0480241	48 (1.22)	24 (0.61)	8.0 (0.74)	1	2.9 (1.3)	01362716443
WTE0480301	48 (1.22)	30 (0.76)	10.0 (0.93)	1	3.0 (1.4)	01362716501
WTE0480361	48 (1.22)	36 (0.91)	12.0 (1.11)	1	3.2 (1.5)	01362716541
WTE0480481	48 (1.22)	48 (1.22)	16.0 (1.49)	1	3.4 (1.5)	01362716444
WTE0600241	60 (1.52)	24 (0.61)	10.0 (0.93)	1	4.0 (1.8)	01362716446
WTE0600301	60 (1.52)	30 (0.76)	12.5 (1.16)	1	4.2 (1.9)	01362716542
WTE0600361	60 (1.52)	36 (0.91)	15.0 (1.39)	1	4.4 (2.0)	01362716543
WTE0600421	60 (1.52)	42 (1.67)	17.5 (1.63)	1	4.5 (2.0)	01362716447
WTE0600481	60 (1.52)	48 (1.22)	20.0 (1.86)	1	4.7 (2.1)	01362716544
WTE0600601	60 (1.52)	60 (1.52)	25.0 (2.32)	1	5.0 (2.3)	01362716450
WTE0720241	72 (1.83)	24 (0.61)	12.0 (1.11)	1	4.2 (1.9)	01362716458
WTE0720301	72 (1.83)	30 (0.76)	15.0 (1.39)	1	4.4 (2.0)	01362716460
WTE0720361	72 (1.83)	36 (0.91)	18.0 (1.67)	1	4.6 (2.1)	01362716545

Warm Tiles™ Elite WTE Mat

Floor Warming Mats. For Residential and Commercial Applications.

Standard Product Selection for 120 Vac

Catalog Number	Length in (m)	Width in (m)	Heated Area ft ² (m ²)	Carton Quantity	Carton Weight lb (kg)	UPC
WTE0720421	72 (1.83)	42 (1.67)	21.0 (1.95)	1	4.8 (2.2)	01362716463
WTE0720481	72 (1.83)	48 (1.22)	24.0 (2.23)	1	5.0 (2.3)	01362716539
WTE0720601	72 (1.83)	60 (1.52)	30.0 (2.79)	1	5.4 (2.4)	01362716464
WTE0840241	84 (2.13)	24 (0.61)	14.0 (1.30)	1	4.3 (2.0)	01362716468
WTE0840301	84 (2.13)	30 (0.76)	17.5 (1.63)	1	4.5 (2.0)	01362716469
WTE0840361	84 (2.13)	36 (0.91)	21.0 (1.95)	1	4.8 (2.2)	01362716470
WTE0840421	84 (2.13)	42 (1.67)	24.5 (2.28)	1	5.0 (2.3)	01362716472
WTE0840481	84 (2.13)	48 (1.22)	28.0 (2.60)	1	5.2 (2.4)	01362716473
WTE0840601	84 (2.13)	60 (1.52)	35.0 (3.25)	1	5.7 (2.6)	01362716475
WTE0960241	96 (2.44)	24 (0.61)	16.0 (1.49)	1	4.4 (2.0)	01362716476
WTE0960301	96 (2.44)	30 (0.76)	20.0 (1.86)	1	4.7 (2.1)	01362716440
WTE0960361	96 (2.44)	36 (0.91)	24.0 (2.23)	1	5.0 (2.3)	01362716480
WTE0960421	96 (2.44)	42 (1.67)	28.0 (2.60)	1	5.2 (2.4)	01362716479
WTE0960481	96 (2.44)	48 (1.22)	32.0 (2.97)	1	5.5 (2.5)	01362716478
WTE0960601	96 (2.44)	60 (1.52)	40.0 (3.72)	1	6.0 (2.7)	01362716477
WTE1080241	108 (2.74)	24 (0.61)	18.0 (1.67)	1	4.6 (2.1)	01362716474
WTE1080301	108 (2.74)	30 (0.76)	22.5 (2.09)	1	4.9 (2.2)	01362716471
WTE1080361	108 (2.74)	36 (0.91)	27.0 (2.51)	1	5.2 (2.4)	01362716467
WTE1080421	108 (2.74)	42 (1.67)	31.5 (2.93)	1	5.5 (2.5)	01362716466
WTE1080481	108 (2.74)	48 (1.22)	36.0 (3.34)	1	5.8 (2.6)	01362716465
WTE1080601	108 (2.74)	60 (1.52)	45.0 (4.18)	1	6.4 (2.9)	01362716461
WTE1180241	118 (3.00)	24 (0.61)	19.7 (1.83)	1	4.7 (2.1)	01362716451
WTE1180301	118 (3.00)	30 (0.76)	24.6 (2.29)	1	5.0 (2.3)	01362716449
WTE1180361	118 (3.00)	36 (0.91)	29.5 (2.74)	1	5.3 (2.4)	01362716448
WTE1180421	118 (3.00)	42 (1.67)	34.4 (3.20)	1	5.7 (2.6)	01362716445
WTE1180481	118 (3.00)	48 (1.22)	39.3 (3.65)	1	6.0 (2.7)	01362716481
WTE1180601	118 (3.00)	60 (1.52)	49.2 (4.57)	1	6.6 (3.0)	01362716441

Warm Tiles™ Elite WTE Mat

Floor Warming Mats. For Residential and Commercial Applications.

Standard Product Selection for 240 Vac

Catalog Number	Length m (in)	Width m (in)	Heated Area m ² (ft ²)	Carton Quantity	Carton Weight kg (lb)	UPC
WTE0400272	40 (1.02)	27 (0.69)	7.5 (0.70)	1	2.9 (1.3)	01362716513
WTE0400322	40 (1.02)	32 (0.81)	8.9 (0.83)	1	3.0 (1.4)	01362716512
WTE0400402	40 (1.02)	40 (1.02)	11.1 (1.03)	1	3.1 (1.4)	01362716462
WTE0400482	40 (1.02)	48 (1.22)	13.3 (1.24)	1	3.2 (1.5)	01362716507
WTE0480242	48 (1.22)	24 (0.61)	8.0 (0.74)	1	2.9 (1.3)	01362716510
WTE0480302	48 (1.22)	30 (0.76)	10.0 (0.93)	1	3.0 (1.4)	01362716498
WTE0480362	48 (1.22)	36 (0.91)	12.0 (1.11)	1	3.2 (1.5)	01362716499
WTE0480482	48 (1.22)	48 (1.22)	16.0 (1.49)	1	3.4 (1.5)	01362716500
WTE0600242	60 (1.52)	24 (0.61)	10.0 (0.93)	1	4.0 (1.8)	01362716482
WTE0600302	60 (1.52)	30 (0.76)	12.5 (1.16)	1	4.2 (1.9)	01362716483
WTE0600362	60 (1.52)	36 (0.91)	15.0 (1.39)	1	4.4 (2.0)	01362716484
WTE0600422	60 (1.52)	42 (1.67)	17.5 (1.63)	1	4.5 (2.0)	01362716503
WTE0600482	60 (1.52)	48 (1.22)	20.0 (1.86)	1	4.7 (2.1)	01362716504
WTE0600602	60 (1.52)	60 (1.52)	25.0 (2.32)	1	5.0 (2.3)	01362716505
WTE0720242	72 (1.83)	24 (0.61)	12.0 (1.11)	1	4.2 (1.9)	01362716506
WTE0720302	72 (1.83)	30 (0.76)	15.0 (1.39)	1	4.4 (2.0)	01362716508
WTE0720362	72 (1.83)	36 (0.91)	18.0 (1.67)	1	4.6 (2.1)	01362716509
WTE0720422	72 (1.83)	42 (1.67)	21.0 (1.95)	1	4.8 (2.2)	01362716511
WTE0720482	72 (1.83)	48 (1.22)	24.0 (2.23)	1	5.0 (2.3)	01362716516
WTE0720602	72 (1.83)	60 (1.52)	30.0 (2.79)	1	5.4 (2.4)	01362716517
WTE0840242	84 (2.13)	24 (0.61)	14.0 (1.30)	1	4.3 (2.0)	01362716518
WTE0840302	84 (2.13)	30 (0.76)	17.5 (1.63)	1	4.5 (2.0)	01362716519
WTE0840362	84 (2.13)	36 (0.91)	21.0 (1.95)	1	4.8 (2.2)	01362716524
WTE0840422	84 (2.13)	42 (1.67)	24.5 (2.28)	1	5.0 (2.3)	01362716526
WTE0840482	84 (2.13)	48 (1.22)	28.0 (2.60)	1	5.2 (2.4)	01362716528
WTE0840602	84 (2.13)	60 (1.52)	35.0 (3.25)	1	5.7 (2.6)	01362716529
WTE0960242	96 (2.44)	24 (0.61)	16.0 (1.49)	1	4.4 (2.0)	01362716531
WTE0960302	96 (2.44)	30 (0.76)	20.0 (1.86)	1	4.7 (2.1)	01362716532
WTE0960362	96 (2.44)	36 (0.91)	24.0 (2.23)	1	5.0 (2.3)	01362716534
WTE0960422	96 (2.44)	42 (1.67)	28.0 (2.60)	1	5.2 (2.4)	01362716535
WTE0960482	96 (2.44)	48 (1.22)	32.0 (2.97)	1	5.5 (2.5)	01362716536
WTE0960602	96 (2.44)	60 (1.52)	40.0 (3.72)	1	6.0 (2.7)	01362716540
WTE1080242	108 (2.74)	24 (0.61)	18.0 (1.67)	1	4.6 (2.1)	01362716502
WTE1080302	108 (2.74)	30 (0.76)	22.5 (2.09)	1	4.9 (2.2)	01362716492
WTE1080362	108 (2.74)	36 (0.91)	27.0 (2.51)	1	5.2 (2.4)	01362716533
WTE1080422	108 (2.74)	42 (1.67)	31.5 (2.93)	1	5.5 (2.5)	01362716530
WTE1080482	108 (2.74)	48 (1.22)	36.0 (3.34)	1	5.8 (2.6)	01362716527
WTE1080602	108 (2.74)	60 (1.52)	45.0 (4.18)	1	6.4 (2.9)	01362716525
WTE1180242	118 (3.00)	24 (0.61)	19.7 (1.83)	1	4.7 (2.1)	01362716523
WTE1180302	118 (3.00)	30 (0.76)	24.6 (2.29)	1	5.0 (2.3)	01362716522
WTE1180362	118 (3.00)	36 (0.91)	29.5 (2.74)	1	5.3 (2.4)	01362716521
WTE1180422	118 (3.00)	42 (1.67)	34.4 (3.20)	1	5.7 (2.6)	01362716520
WTE1180482	118 (3.00)	48 (1.22)	39.3 (3.65)	1	6.0 (2.7)	01362716515
WTE1180602	118 (3.00)	60 (1.52)	49.2 (4.57)	1	3.0 (6.6)	01362716514

FLOOR WARMING

Warm Tiles™ Elite WTE Mat

Floor Warming Mats. For Residential and Commercial Applications.

Custom Floor Warming-Mats (WTE)

If the layout or installation conditions prevent the use of the standard Warm Tiles™ Elite product offering, our team will work with you to create custom WTE mats tailored to your unique specifications and layout. Submit the WTE Custom Order Form with all the required information, and the Warm Tiles™ Application Engineering team will design a custom mat just for you.

Catalog Number Guide

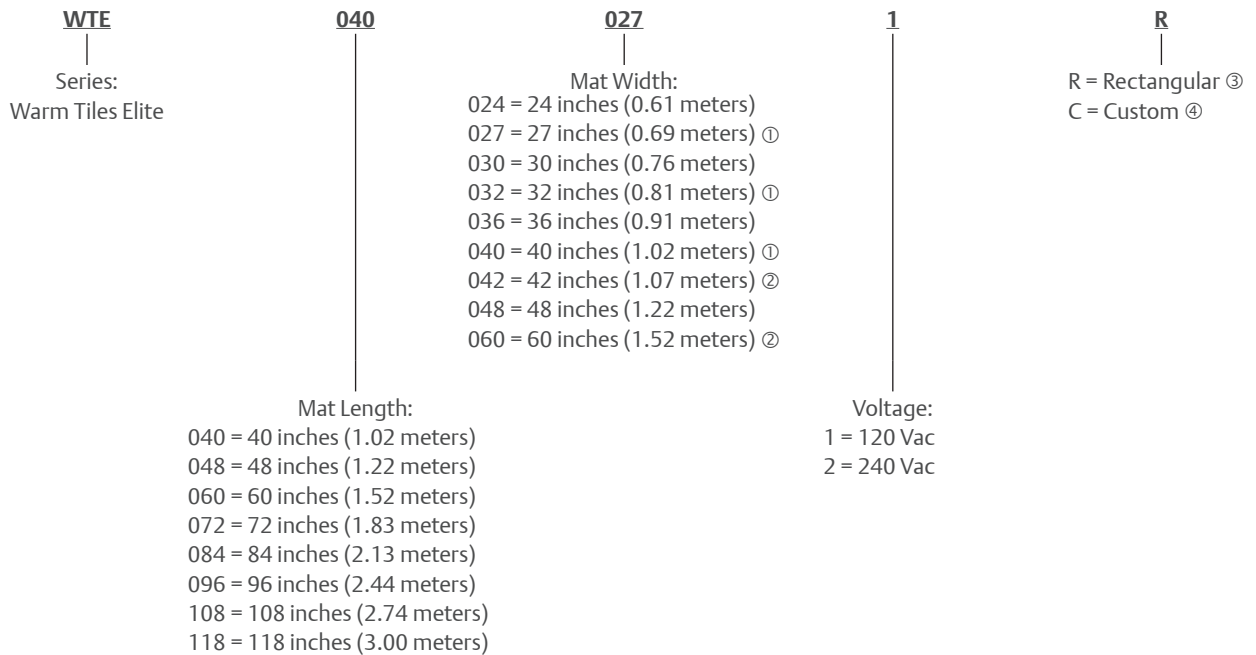

- ① Only available for mat length of 40 in (1.02 m).
- ② Not available for mat lengths of 40 in and 48 in (1.02 and 1.22 m).
- ③ Custom rectangular shape mat without any notches or cutouts will have a suffix "R" after its main part number. Example: WTE0630491R – 63 in x 49 in (1.60 m x 1.24 m), 120 Vac special size RECTANGULAR custom WTE mat.
- ④ Irregular shape custom mat that may contain any combination of notches, cutouts, bevels, etc. Example: WTE0630491C023 – 63 inches x 49 inches (1.60 m x 1.24 m), 120 Vac special size irregular shape CUSTOM mat with a unique design (three-digit code behind "C" suffix is assigned by application engineering team).

Custom Mat Shapes

WTE mats can be provided in custom sizes or shapes – some typical shapes may include:

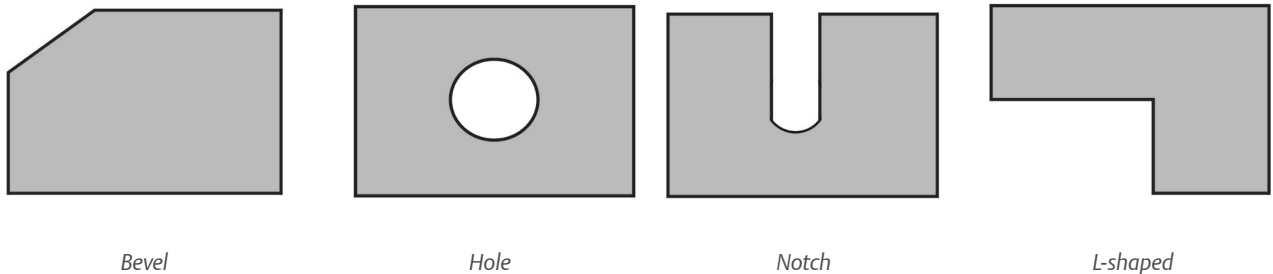

Note: Contact a local sales representative for assistance.

Warm Tiles™ FG and FGS Thermostats

Floor Warming. For Residential and Commercial Applications.

Product Overview

- Warm Tiles™ floor warming thermostats are designed to offer precise temperature control for all Warm Tiles™ floor warming systems.

Applications

- Monitors and regulates the warmth of Warm Tiles™ heated floors.

Features

- FGS programmable thermostat cycles on and off automatically to suit 5/2 or full 7 day schedules.
- FG non-programmable thermostat for manual operation with a simple temperature adjustment and on/off switch.
- Thermostats have dual 120/240 Vac design and control loads up to 15 Amps total system current.
- Integrated GFCI meets NEC/CEC electrical code with no need to buy and install a separate GFCI on systems under 15 amps.
- Responsive buttons and intuitive feedback simplify operation.
- Large, easy to read, backlit LCD display.
- Eighteen month limited warranty.

Certifications

- CSA Certified to US and Canadian Standards.

Notes

- Thermostats are designed for indoor use only and should not be installed in areas where it can be exposed to water or rain.



Floor Temperature



FG Thermostat



Event/ Program



FGS Thermostat



FLOOR WARMING

Product Selection

Catalog Number	Description	Carton Quantity	Carton Weight lb (kg)	UPC
FG	120/240 Vac dual-voltage 15A non-programmable thermostat	5	8 (3.6)	01362716585
FGS	120/240 Vac dual-voltage 15A programmable thermostat	5	8 (3.6)	01362716584

Warm Tiles™ ES and ESW WiFi ColorTouch Thermostats

Floor Warming. For Residential and Commercial Applications.

Product Overview

- The Warm Tiles ES ColorTouch floor warming thermostat is designed to offer precise temperature control for all Warm Tiles floor warming systems.
- The Warm Tiles ESW WiFi ColorTouch Thermostat allows monitoring and precise control of Warm Tiles floor warming systems remotely from a web browser, Android or iOS smartphone or tablet. It offers all the same features of the ES Thermostat with the addition of wifi capability for remote access.

Applications

- Monitors and regulates the warmth of Warm Tiles heated floors.
- ESW allows for remote monitoring and controlling of the Warm Tiles floor warming systems, via a user-friendly app or laptop pc.

Features

- Standard Thermostat:
 - 3.5" color screen with easy interactive touch control.
 - Programmable thermostat allowing for 6 programming periods per day.
 - Integral relay switch can control up to 15 amps at either 115 Vac or 230 Vac.
 - Includes 5 mA built-in ground fault circuit interrupter (GFCI) with indicator light.
 - Track thermostat power consumption in the energy log.
 - Lockout feature prevents others from tampering with thermostat settings.
 - 5-year battery back-up included.
 - 3 year plus 3 month warranty.
- ES Thermostat:
 - Three control modes: Floor, Ambient, Floor/Ambient
- ESW WiFi Thermostat:
 - WLAN connectivity for remote access.
 - Connects to standard home wifi, no hub required.
 - Monitor and precisely control any Warm Tiles floor warming system from a web browser, Android™ or iOS™ smartphone or tablet.
 - Compatible with iPhone™ and iPad™ devices using iOS™ operating system.
 - Compatible Samsung™ and Motorola™ devices using Android™ operating systems.
 - Local weather information can be displayed on the thermostat with just a tap of the screen.
 - Black back-lit screen with white characters proves high contrast for easy readability from a distance and in bright or dark environments.

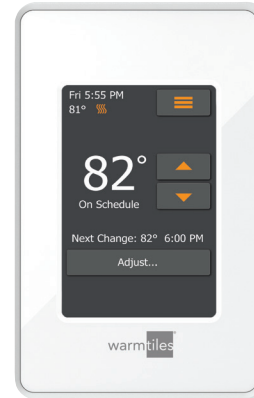

ES Thermostat

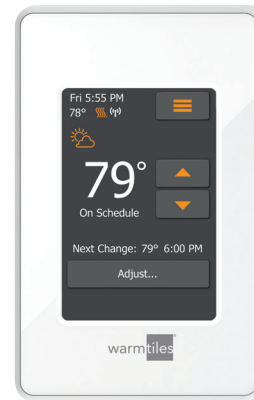

ESW Thermostat



Certifications

- UL Listed for use in the United States and Canada.

Notes

- Thermostats are designed for indoor use only and should not be installed in areas where it can be exposed to water or rain.

Product Selection

Catalog Number	Description	Dimensions in (mm)	Carton Quantity	Carton Weight lb (kg)	UPC
ES	Color Touch-Screen Thermostat, 115/230 Vac, 15A	3.5x6 (89x152)	1	1 (0.4)	013627002395
ESW	WiFi-enabled Color Touch-Screen Thermostat 120/240V, 15A	3.5x6 (89x152)	1	1 (0.3)	013627002982

Warm Tiles™ Floor Warming Accessories

Floor Warming. For Residential and Commercial Applications.

Product Overview

- Warm Tiles™ provides the right accessories to install our floor warming systems.

Detecto DT1 Heating Cable and Mat Fault Indicator

- The Detecto DT1 heating cable and mat fault indicator (battery operated) is designed to monitor Warm Tiles™ cable or mat systems at every step during installation.
- Detecto DT1 sounds an alarm immediately in the event of a ground fault detection, or an open or shorted connection in the cable.
- One year limited warranty.



Detecto DT1 Heating Cable and Mat Fault Indicator

Relay Kits

- The Warm Tiles™ relay kits (RK1 and RK2) allows you to connect multiple floor warming kits to a single thermostat, when power required exceeds 15 amps.
- One year limited warranty.



RK1 and RK2 Relay Kits

DFTRK Repair Kit

- The DFTRK repair kit can be used to make repairs to damaged floor heating cables and is suitable for use on most types of heating cables/mats with either single or dual conductor heating elements.
- One year limited warranty.



DFTRK Warm Tiles™ Repair Kit

Other Accessories

- Warm Tiles™ offers other accessories including replacement clips, strapping and concrete tape for your floor warming needs.
- One year limited warranty.

Certifications

- Detecto DT1 conforms to European Directives.
- Relay kits (RK1 and RK2) are UL Listed to US and Canadian Safety Standards.



CKT

FLOOR WARMING

Product Selection

Catalog Number	Description	Carton Quantity	Carton Weight lb (kg)	UPC
RK1	Relay kit, 120 Vac, 24 Amps	1	0.5 (0.2)	01362701298
RK2	Relay kit, 240 Vac, 24 Amps	1	0.5 (0.2)	01362701299
DFTRK	Warm Tiles™ repair kit	1	0.5 (0.2)	01362701271
DFTCK	Metal strapping kit (1) 25 ft (7.62 m) reel	1	1.5 (0.7)	01362701638
CKT	Concrete kit tape, 25 ft (7.62 m)	1	0.5 (0.2)	01362701297
10685001	Clips (50 per bag)	1	0.2 (0.1)	01362700283
10739001	Replacement temperature sensor	1	0.3 (0.1)	01362700163
DT1	Detecto electric fault indicator	1	1.0 (0.5)	01362701296
DFTS	EasyStrap Plastic Strapping Strips for DFT cables, 10 Pack	1	0.5 (1.0)	013627001370
DMCS	EasyStrap Plastic Strapping Strips for DMC cables, 25 Pack	1	1.1 (2.4)	013627003804

Engineered for safety and reliability in corrosive environments and hazardous atmospheres.



EASYHEAT

Your local contact: EasyHeat.com

United States

(Headquarters)

Appleton Grp LLC
9377 W. Higgins Road
Rosemont, IL 60018
United States
T +1 800 621 1506

Canada

EGS Electrical Group Canada Ltd.
99 Union Street
Elmira ON, N3B 3L7
Canada
T +1 888 765 2226



easyheat.com



[LinkedIn.com/emerson](https://www.linkedin.com/company/emerson)

The Emerson logo is a trademark and service mark of Emerson Electric Co. © 2021 Emerson Electric Co. EasyHeat, Inc. is a wholly owned subsidiary of Appleton Grp LLC. All other marks are the property of their respective owners. © 2021 Emerson Automation Solutions. All rights reserved. 41000-003 Rev.10



CONSIDER IT SOLVED™